

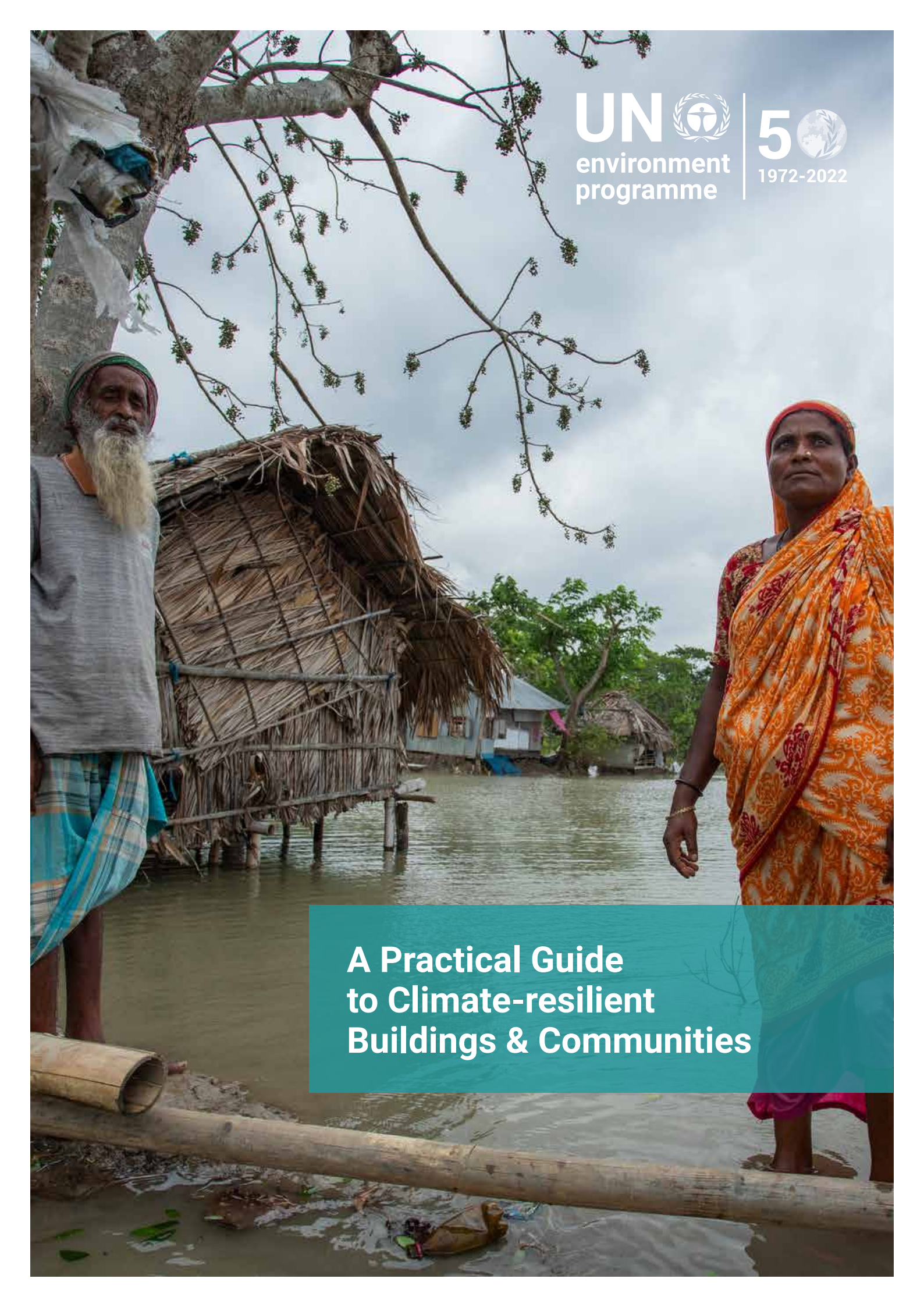

UN
environment
programme



5
1972-2022



**A Practical Guide
to Climate-resilient
Buildings & Communities**

© 2021 United Nations
Environment Programme

ISBN: 978-92-807-3871-1
Job number: DEP/2369/NA

This publication may be reproduced in whole or in part and in any form for educational or non-profit services without special permission from the copyright holder, provided acknowledgement of the source is made. The United Nations Environment Programme would appreciate receiving a copy of any publication that uses this publication as a source.

No use of this publication may be made for resale or any other commercial purpose whatsoever without prior permission in writing from the United Nations Environment Programme. Applications for such permission, with a statement of the purpose and extent of the reproduction, should be addressed to the Director, Communication Division, United Nations Environment Programme, P. O. Box 30552, Nairobi 00100, Kenya.

Disclaimers

The designations employed and the presentation of the material in this publication do not imply the expression of any opinion whatsoever on the part of the Secretariat of the United Nations concerning the legal status of any country, territory or city or area or its authorities, or concerning the delimitation of its frontiers or boundaries. For general guidance on matters relating to the use of maps in publications please go to <http://www.un.org/Depts/Cartographic/english/htmain.htm>

Mention of a commercial company or product in this document does not imply endorsement by the United Nations Environment Programme or the authors. The use of information from this document for publicity or advertising is not permitted. Trademark names and symbols are used in an editorial fashion with no intention on infringement of trademark or copyright laws.

The views expressed in this publication are those of the authors and do not necessarily reflect the views of the United Nations Environment Programme. We regret any errors or omissions that may have been unwittingly made.

Important Note: The technical suggestions in this document are for informational purposes only and do not constitute design guidance. Always engage architectural and engineering professionals to ensure that any intervention is appropriate for your specific needs and conditions.

© Maps, photos and illustrations as specified

Suggested Citation:

United Nations Environment Programme (2021). A Practical Guide to Climate-resilient Buildings & Communities. Nairobi.

Production

United Nations Environment Programme (UNEP)

<https://www.unep.org/resources/practical-guide-climate-resilient-buildings>

**UNEP promotes
environmentally sound
practices globally and
in its own activities. Our
distribution policy aims to reduce
UNEP's carbon footprint.**

**A Practical Guide
to Climate-resilient
Buildings & Communities**

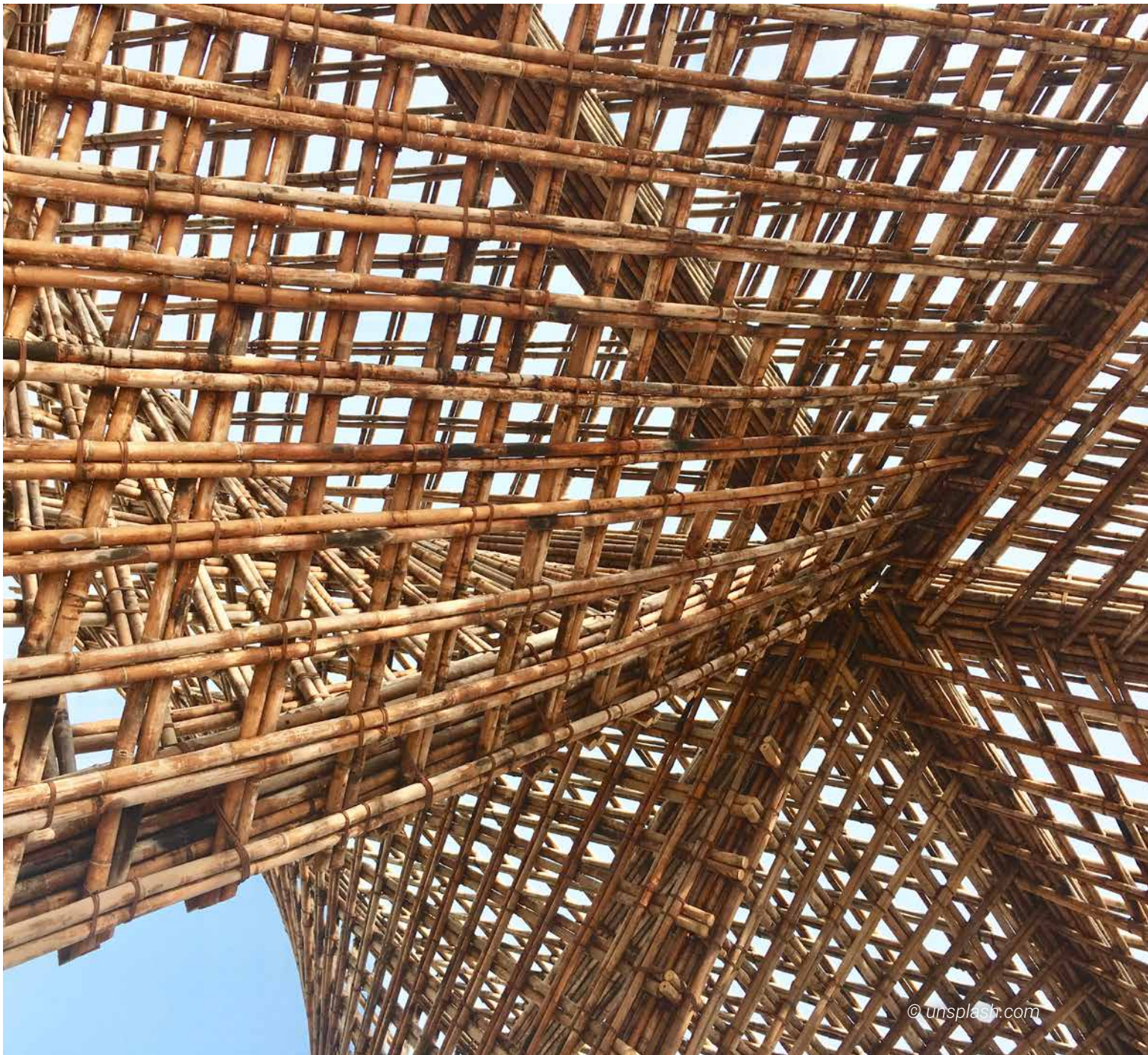

© unsplash.com

Acknowledgements

Lead Authors: Rajat Gupta (Oxford Brookes University), Mittul Vahanvati (RMIT University), Julia Häggström (SEfficiency), Jacob S. Halcomb (SEfficiency).

Contributing Authors: Matt Gregg (Oxford Brookes University), G. Bradley Guy, Michelle Bosquet (SEfficiency).

Supervision and Coordination: Jacob S. Halcomb (SEfficiency), Eva Comba (UNEP)

Graphic Design and Layout: Phoenix Design Aid A/S

Cover Image: Khulna, Bangladesh.⁷

Peer Review: Tabitha Goodman (Association for Energy Affordability), Kent Buchanan (Ministry of Environment, Forestry and Fisheries, South Africa), Kathryn Conway (Conway Associates), Natasha Nass (UNEP), Jonathan Duwyn (UNEP), Jessica Troni (UNEP), Maria Baviera (UNEP), Marcus Nield (UNEP).

Foreword

**Martina Otto**

Head of the Cities Unit
at UN Environment Programme,
and Head of the Global Alliance
for Buildings & Construction

**Jessica Troni**

Head of the Climate
Change Adaptation Unit,
UN Environment
Programme

The buildings and construction sector is a major contributor to climate change, responsible for 38 per cent of global energy-related CO₂ emissions, (GlobalABC, 2020), effectively reaching in 2019 the highest level of CO₂ emissions ever recorded for this sector. At the same time, we are already experiencing pressure on living conditions and an increase in damage to assets and asset value from extreme weather events; notably in coastal areas where the majority of the world's population lives. The expected impacts of climate change, including sea level rise, heat waves, droughts, and cyclones, will increasingly affect the built environment and in turn the society as a whole.

Recent research predicts that by 2050, 1.6 billion urban dwellers will be regularly exposed to extreme high temperatures and over 800 million people living in more than 570 cities will be vulnerable to sea level rise and coastal flooding (C40, 2018). When ill-suited to their local environment and strongly exposed to extreme climate conditions, buildings become drivers of vulnerability, rather than providing shelter, leading to both human tolls and economic losses. Low-income, informal, over-crowded and ill-planned settlements face the highest risk from climate change. During the past two decades, almost 90 per cent of deaths from storms took place in lower-income countries, though they endured only a quarter of total storms (UNISDR, 2015).

Mitigation and adaptation both need to be pursued actively to address and respond to the current and future climate threats. Future-proofing the building



sector must be a center piece of building resilience and GHG emissions mitigation. For example, passive design or use of green roofs and facades reduces vulnerability to heat for building users and reduces their energy demand for mechanical cooling for thermal comfort.

Adaptation in the buildings and construction sector is still in its early stages and efforts need to be rapidly scaled up to cope with increasingly intense climate change impacts. This practical guide presents a range of adaptation interventions to respond to droughts, flooding, sea level rise, heatwaves and warming, cyclones and strong winds for different building types and different settings, which governments and policy makers can promote and scale up by integrating them into policies and regulations for the built environment. It also reflects on the possible landscape level green infrastructure measures that can deliver adaptation benefits at an urban scale.











In this guide, special attention has been given to most vulnerable countries and groups, where the built environment is largely self-constructed. Here, working with the inhabitants of informal settlements and their community organizations in improving housing quality and providing needed infrastructure and services is a powerful adaptation strategy for governments to support.









By integrating locally adapted climate adaptation measures in post-disaster reconstruction, owner-driven construction or slum upgrading, as well as building retrofits and new constructions, authorities, project developers, funders and community members can motivate and educate people, provide incentives and develop a conducive environment for the promotion and innovation of sustainable building design and construction standards that progress community resilience to climate change.

Table of Contents

Acknowledgements	2
Foreword	3
Table of contents	5
List of figures	8
List of tables	9
Abbreviations and acronyms	10
Glossary	12
1 Introduction	14
1.1 Aim of this practical guide.....	15
2 Challenges and impacts of a changing climate on the built environment	17
2.1 Vulnerability and hazards	18
2.1.1 <i>Introduction to the interplay between vulnerability and risk in the context of climate hazards</i>	18
2.1.2 <i>Poverty and/or affordability</i>	21
2.1.3 <i>Gender and social discrimination</i>	21
2.2 Adaptation and resilience in the building sector	22
2.3 Buildings and climate risks	22
2.4 A warming climate, heat waves and droughts	25
2.4.1 <i>Heat waves and their impacts</i>	25
2.4.2 <i>Drought</i>	25
2.5 Storms, floods and sea-level rise	26
2.5.1 <i>Cyclones and storm events</i>	26
2.5.2 <i>Sea-level rise</i>	26
2.5.3 <i>Flooding</i>	27



	3 General approaches and design principles	29
	3.1 Overview.....	30
	3.2 The role of institutional policy frameworks in adapting the built environment	30
	3.2.1 <i>Political will and capacity</i>	30
	3.2.2 <i>Building codes</i>	31
	3.3 Design and construction principles	32
	3.3.1 <i>Human-climate-building interactions</i>	32
	3.3.2 <i>Owner-driven reconstruction for adaptation</i>	32
	3.3.3 <i>Frangible architecture or “planning for damage”</i>	33
	3.3.4 <i>Triage design for rapid reconstruction after disasters</i>	34
	3.4 Nature-based adaption for design and construction.....	35
	4 Adaptation ideas for thermal regulation and comfort	39
	4.1 Building site and orientation	40
	4.2 Building configuration and layout	42
	4.3 Natural ventilation	43
	4.3.1 <i>Ventilation in Hot and humid climate</i>	44
	4.3.2 <i>Ventilation in hot and dry climate</i>	46
	4.4 Shading and cool surfaces.....	48
	4.4.1 <i>Glazing, openings and shading</i>	48
	4.4.2 <i>Roofs and cool surfaces</i>	50
	4.5 Thermal adaptation in cold and temperate climates	53
	4.5.1 <i>Cold climates</i>	53
	4.5.2 <i>Thermal adaptation in composite and temperate climates</i>	56
	4.6 Materials for thermal comfort	56

	5 Adaptation ideas for specific climate risks: flooding, droughts and cyclones	58
  	5.1 Changing rainfall patterns and droughts	59
   	5.2 Adapting to stronger storms and flooding	61
	5.2.1 <i>Wet-Dry architecture</i>	64
	5.3 Cyclones and wind-storms	67
	5.3.1 <i>Roofs</i>	67
	5.3.2 <i>Fastening roofs and walls</i>	69
	5.3.3 <i>Building shape</i>	70
	5.4 Material selection	70
	6 Conclusion, recommendations and next steps	76
	6.1 Next Steps	78
	7 Additional Resources	83
	References	86

INTERACTIVE FEATURES

This guide includes interactive features to help you navigate the report and access further information to use and share.

Navigating the report

 **Contents** – go straight to any chapter or section from the contents list

 **Home** – go back to the content list from any page by clicking the Contents icon



List of figures

Figure 1. Components of vulnerability	19
Figure 2. Cyclone Fani hits northeastwards into West Bengal state.....	22
Figure 3. How the environmental impacts of climate change affect buildings and the people and processes within them.	23
Figure 4. Climate change impacts on buildings.....	24
Figure 5. Drought-caused soil subsidence impacting foundation and wall structure	26
Figure 6. Water rescue crew on site searching for survivors after dangerous flooding.....	27
Figure 7. Division of damages to buildings caused by floods	28
Figure 8. Dynamic three-way interaction between climate, people and buildings dictates energy needs in buildings.....	32
Figure 9. House-within-a-House.....	34
Figure 10. KODA house.....	35
Figure 11. Urban morphological map of Addis Ababa, Ethiopia	37
Figure 12. Components of a Sponge City	37
Figure 13. Plant trees and shrubs to funnel breezes	41
Figure 14. Ideal orientation of a building in both hemispheres	41
Figure 15. Low perimeter to area ratio and high P/A illustrated.....	42
Figure 16. Cross ventilation through shallow plan.....	43
Figure 17. The Juanapur slum resettlement in New Delhi, India.....	43
Figure 18. Design for a house in warm and humid climate.....	44
Figure 19. Hot and humid climate, maximising breeze, using vegetation to advantage.....	45
Figure 20. Daily energy management in traditional buildings in Nagapattinam, India	45
Figure 21. Different courtyard dimensions for ventilation and mutual shading.....	46
Figure 22. Two story wind tower in Iran	47
Figure 23. Central wind tower with water for cooling for use in hot and dry climates	47
Figure 24. Earth Air Tunnel system utilizing underground temperature to cool.....	48
Figure 25. Projection factor calculated by dividing overhang by length of window	49
Figure 26. Windows and shading strategies for hot and dry climate regions	50
Figure 27. Cool roof paint.....	51
Figure 28. Secondary roof structure, also known as “fly roof.”	52
Figure 29. Shade fabric	52
Figure 30. Direct solar gain system.....	55
Figure 31. Solarium with Trombe wall as used in High Mountain regions	55
Figure 32. Solar chimney wall	56
Figure 33. Rainwater harvesting and recharge system as used in India	59
Figure 34. Rainwater harvesting tank, Uganda	60
Figure 35. Lattice units for storm run-off control, pedestrian pathways and soil conservation	60
Figure 36. Rainwater harvesting combined with a pavement design at an interval dependent on the run-off.....	60

Figure 37. Flood resistant home in Kerala, India	61
Figure 38. Malaysian water building design	62
Figure 39. Shelter of kindness – raised emergency shelter as a multipurpose hall.....	62
Figure 40. Dwellings on stationary plinths vs. the amphibious dwelling	63
Figure 41. Amphibious house in New Orleans, USA	63
Figure 42. Qualitative assessment of structural and non-structural adaptation measures	65
Figure 43. Examples of autonomous adaptation measures.....	66
Figure 44. Hip roof performing well under wind forces.....	67
Figure 45. Roof construction for strong winds.....	68
Figure 46. Central shaft with aerodynamic features designed to reduce wind forces during an extreme wind event.	69
Figure 47. Reinforcing a roof	69
Figure 48. Connection between vertical reinforcement and the seismic band at lintel level	69
Figure 49. Dome dwellings	70

List of tables

Table 1. Vulnerability determinants in the built environment from a multi-disciplinary understanding (From: Vahanvati, 2018).....	20
Table 2. Relative human and economic costs of geophysical disasters on continents 1998-2017	21
Table 3. Representative list of common building materials and systems	72
Table 4. Thermal performance of select assemblies	73
Table 5. Noise transmission of select assemblies	74
Table 6. Water resistance of materials.....	74
Table 7. Summary of adaptive approaches by climate impact and sphere of construction.....	80



Abbreviations and acronyms

AAC	Aerated Autoclave Concrete	ND-GAIN	Notre Dame Global Adaptation Index
ASC	Adaptation Sub-Committee	NSSL	National Severe Storms Laboratory
BEE	Bureau of Energy Efficiency (India)	ODHR	Owner-Driven Housing Reconstruction
BEEP	Indo-Swiss Building Energy Efficiency Project	RCC	Reinforced Concrete Cement
BMTPC	Building Materials and Technology Promotion	SRI	Solar Reflectance Index
CCRA	Climate Change Risk Assessment	SuDS	Sustainable Drainage Systems
CDD	Cooling Degree Days	UHI	Urban Heat Island
DEFRA	Department for Environment, Food & Rural Affairs	UN DESA	United Nations Department of Economic and Social Affairs
GFRG	Glass Fibre Reinforced Gypsum	UNDRR	United Nations Office for Disaster Risk Reduction (formerly UNISDR)
GHG	Greenhouse Gas	UNEP	United Nations Environment Programme
GI	Green Infrastructure	UN-Habitat	United Nations Human Settlements Programme
GIS	Geographic Information System	UNISDR	United Nations International Strategy for Disaster Reduction (now UNDRR)
HDD	Heating Degree Days	WFRop	Window to Floor Area ratio
IFRC	International Federation of Red Cross and Red Crescent Societies	WWR	Window to Wall Ratio
IGBC	Indian Green Building Council		
IPCC	Intergovernmental Panel on Climate Change		
LGSF	Light Gauge Steel Frame		
NbS	Nature-based Solutions		



Glossary

Concrete breakwater at mediterranean coast of Alexandria © Shutterstock

Cooling / Heating degree days: A "degree day" is determined by comparing the mean average outdoor temperature with a defined baseline temperature for indoor comfort. Degree days are a normalizing measurement commonly used in calculations relating to energy consumption in buildings.

Low-E – A measure of emissivity, the characteristic of a material to radiate thermal energy. Glass is typically highly emissive, warming indoor spaces. Low-E glass typically has a coating or other additive to reduce the heat transfer to inside spaces.

Net zero building: Energy efficient building with all remaining energy supplied from on-site and/or off-site renewable energy sources. The net final consumption would be zero or negative (also called positive energy building).

Passivhaus Standard: One of the most stringent voluntary standards for energy efficient buildings in the world. The requirements are defined by final energy consumption and airtightness.

R-value: Like U-value, R-Value is a measurement of thermal performance. However, instead of measuring thermal conductivity (how easily heat passes through a material) it measures resistance to heat transfer. Some countries use R-value for their standards instead of U-value.

Solar reflectance index (SRI): This index is a method to calculate the albedo of a material. In warm climates, materials with a high SRI number are suggested.

Thermal mass: The property of a building that uses materials to absorb heat as a way to buffer to changes in outside temperatures. Stone floors or wall have a high thermal mass. Wood walls have a low thermal mass.

Urban heat island (UHI): An urban area that is significantly warmer than its surrounding rural areas due to human activities. The temperature difference is usually larger at night than during the day and is most apparent when winds are weak.

U-value: This indicates the thermal transmittance of a property and indicates its thermal performance. U-value is the property of heat transmission in unit time through unit area of a building material or assembly and the boundary air films, induced by unit temperature difference, between the environments on each side. The lower the U-value of a material, the better its heat-insulating capacity.

Vernacular architecture: Architecture characterised by the use of local materials and knowledge, usually without the supervision of professional architects.

Window-to-floor area ratio (WFRop): A calculation rule of thumb to help determine optimum window size for natural ventilation, lighting, or other passive (non-mechanical) strategies for indoor comfort.

Window-to-wall ratio (WWR): The ratio of glazing (windows, skylights, etc. divided by the total exterior wall area of a building. This is an important guideline because windows have a large impact on the energy needs of a building.

1 Introduction

Pemba, Mozambique - 1 May 2019 - Aerial view of devastated fishing village after Cyclone Kenneth in northern Mozambique. © iStock.com

The 2019 Tropical Cyclone Idai, one of the strongest cyclones to strike Africa, and Tropical Cyclone Kenneth, the strongest storm in modern memory to lash Mozambique, devastated infrastructure and destroyed homes, workplaces and schools through high winds, flooding and heavy rainfall. The severity and extent of the damage from these two events have raised awareness and desire for improved approaches to ensure homes and other buildings are resilient and adapted for the warming climate and the associated increased risk of natural hazards.

These two recent cyclones are only an example of the global challenges projected by a changing climate over the coming century. During the past two decades, almost 90 per cent of deaths from weather-related disasters took place in lower-income countries, though they endured only a quarter of total weather events.⁹ There is consensus in the scientific community that climate change is increasing the frequency, intensity, spatial extent, duration and timing of extreme weather and climate events, leading to increased climate-related hazards.¹⁰

Climate hazards can cause loss of life, injury or other health impacts, as well as damage to, and loss of, property, infrastructure, livelihoods, service provision and environmental resources. Between 2000-2019, there has been a worldwide average of 361 disasters per year. In 2019, approximately 91 million people were affected by natural disasters across the globe. It has been estimated that global economic losses due to weather and climate-related events amounted to 0.4 per cent of global GDP in 2017.¹¹ While not all events can be directly attributed to climate change, the uncertainty, frequency and intensity of extreme weather events is growing, increasing the impact on our built environment and creating a call for attention.

For the twenty-first century, climate scenarios predict more extreme weather-related events, such as heat waves and excessive precipitation. The most severe effects are predicted to occur in tropical areas, where many developing countries are located. According to the Notre Dame Global Adaptation Index (ND-GAIN), countries at the highest risk of climate change are concentrated in Africa and South/Southeast Asia, where the capacity to prevent or cope with climate impacts is poor. It is

further expected that these regions will host nearly all of the anticipated 2.5 million additional urban residents by 2050.¹²

The increase of storm events with the increase in urbanization and population growth is placing additional pressure on decision-makers, cities and local governments to adequately address these risks and ensure the safety and well-being of their residents. Furthermore, climate hazards tend to be particularly detrimental to the most disadvantaged groups of society, such as the elderly and women, who are disproportionately exposed and vulnerable to climate hazards.¹³

The huge impacts, loss of life and societal risks of these natural disasters do not come ashore with the storms or down the rivers with the floods. In fact, these impacts are a result of society's interaction with the hazard and the natural environment. Disasters are produced when people and their settlements are either exposed and vulnerable or ill-suited to their local environment and conditions. Disasters are not only natural and are not neutral actions. Instead, they are a result of insufficient planning and preparation. With thoughtful attention to the design and construction of our built environment, we can reduce vulnerabilities and thereby lower the disaster risk to human life and well-being.¹⁴

1.1 Aim of this practical guide

This practical guide has been prepared because the United Nations Environment Programme (UNEP) recognizes the key role buildings can play in enhancing climate change adaptation, improving resilience and addressing and mitigating risk. Furthermore, there is a recognized need for additional resources addressing good practice for buildings in communities and towns that face risk from disasters but may suffer from a deficit of professionally trained architects, engineers, contractors, manufacturers and other practitioners. Therefore, this note is written for a broad audience, including those with little experience in the building and construction industries.

The term "built environment" encompasses all areas of development, including infrastructure

(roads, utilities and major transportation hubs) as well as buildings, parks and other urban features. While this note will provide an overview of important infrastructure and community-scale considerations, it is principally focused on building structures and their immediate surroundings.

The practical guide sets out to provide an overview of the fundamental types of interventions at the building scale. It specifically offers concepts and approaches for the building envelope, roof, structure, orientation and materials. The approaches and technologies presented in this document are tailored toward a developing country context and a built environment that is largely self-constructed. However, the majority of the techniques identified in this practical guide can be upscaled and applied to buildings of any type, including apartment complexes, hospitals and schools.

Furthermore, given the broad geographic scope, this note will identify and explore scalable interventions that are applicable to key climatic types, with special focus on technical approaches in those regions that are expected to see the highest rates of population growth and urbanization in the coming years. For example, this includes design approaches to minimize heat gain, which could be applied to single family homes in **hot and arid** and **hot and humid** regions but also upscaled for larger commercial or governmental buildings. Many of these countries can also have regions that experience cold or temperate weather; therefore, the report also includes some design ideas for **cold and temperate climates**.

To assist the reader in identifying design principles or technical ideas most relevant for their local needs, this report employs the following icons¹ to highlight applicable risks, climates and approaches. They are:



Drought



Flooding

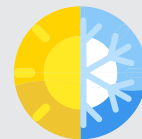

Sea-level Rise

Heatwaves
and WarmingCyclones and
Strong WindsHot and
Arid ClimateHot and
Humid
ClimateTemperate
ClimateCold
ClimateNature-based
Solutions

Materials

¹ Used with permission from SEfficiency ©2020



2 Challenges and impacts of a changing climate on the built environment



This chapter identifies a number of challenges facing the built environment and its inhabitants. Identifying and exploring the factors that contribute to vulnerability allows for a more informed understanding of climatic risks and their impacts on buildings. Technical interventions in buildings that only address the physical hazards outlined in this section, without fully addressing all drivers of vulnerability highlighted below, will ultimately fall short of having the impact needed to secure lives and livelihoods.

2.1 Vulnerability and hazards

Several factors contribute to the vulnerability to climate hazards for a community and its built environment. This section explores these factors by first giving an overview of the interplay between vulnerability, a hazard, and the risk for this hazard (e.g., storm, flooding, drought) to turn into a disaster with devastating impacts on a community. It then details how other factors such as poverty, gender and social discrimination, as well as political will and capacity affect a community's ability to withstand a climate hazard. In places where vulnerability is high, the impacts of a climate hazard will be more severe than in communities where the described challenges have been addressed or mitigated.

2.1.1 Introduction to the interplay between vulnerability and risk in the context of climate hazards

Disaster risk is created by human society's interaction with hazards, and it is often represented in formula as: disaster risk = hazard x vulnerability ($R = H \times V$).¹⁵ The concept of risk explains that disasters are not natural, but rather that they are socially constructed. In other words, vulnerability of a place, property or community, as well as the exposure or how prone the location is to hazards, determines its disaster risk. Moreover, risk is perceived, not actual.

Vulnerability is defined by the United Nations International Strategy for Disaster Reduction (UNISDR) as "the conditions determined by physical, social, economic and environmental factors or processes which increase the susceptibility of an individual, a community, assets or systems to experience the impacts of hazards."¹⁴

This definition highlights the understanding of the pre-existing "condition" as it determines vulnerability.

Vulnerable condition is determined by a product of sensitivity, exposure and lack of adaptive capacity (figure 1).

$$\text{Vulnerability} = \frac{\text{Exposure} \times \text{Sensitivity}}{\text{Adaptive Capacity}}$$

This formula means that a community's degree of vulnerability is often a greater determining factor of the impacts, even more than the severity of the climate hazard. In other words, the greater a community's degree of built-in resiliency, the better it will be able to cope and recover from a climate hazard.

Exposure is defined by UNISDR as "the situation of people, infrastructure, housing, production capacities and other tangible human assets located in hazard-prone areas."¹⁴ The measures of exposure referred to in this definition include:

- number of houses or assets (buildings, hard infrastructure),
- number of people in hazard prone area,
- and severity/magnitude of climate hazard.

Capacity is defined as "the combination of all the strengths, attributes and resources available within an organization, community or society to manage and reduce disaster risks and strengthen resilience."¹⁷ Because capacity includes quantitative aspects as well as qualitative aspects, such as skills and information, it is challenging to measure.

Sensitivity is the attribute or quality of assets, individuals or a society that put all of these at higher risk to the impacts of hazards. For example, elderly, children, women and disabled people can be more sensitive to the impacts of hazards, despite being in safe housing or in low-exposure neighbourhood, due

FIGURE 1. Components of vulnerability (Adapted from UN-Habitat, 2016)¹⁶

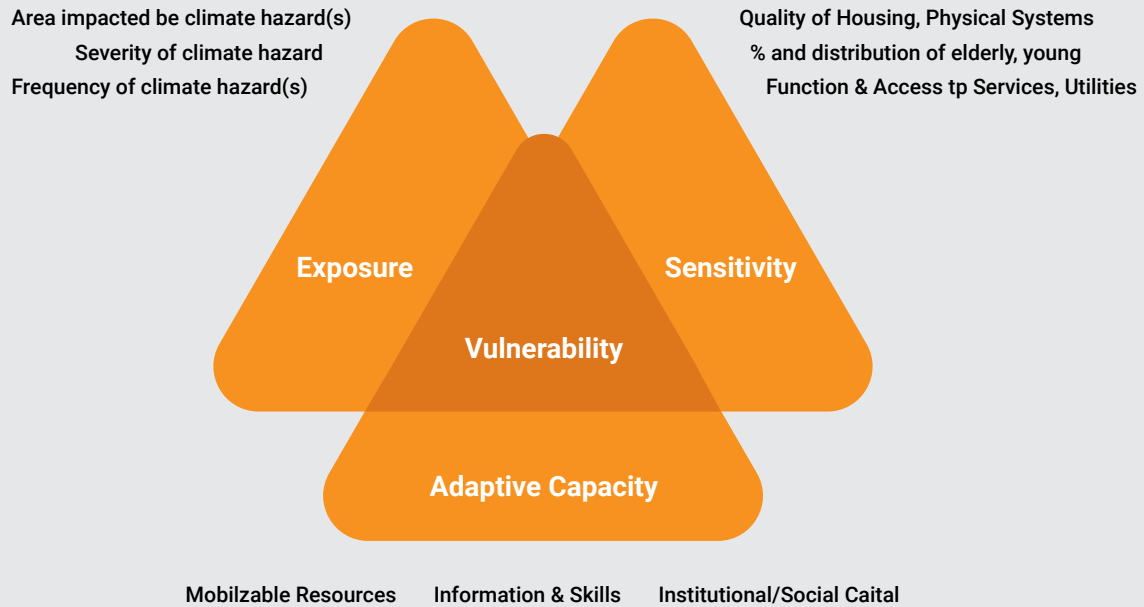

to their limited physical or social capacity. Similarly, a poor-quality asset (such as poor construction quality or unsafe location of housing) can increase the vulnerability of the poorest people in a society to the impacts of hazards and climate events due to their social and economic marginalization.

Table 1 highlights that vulnerability reduction in the built environment, and particularly within the building sector, cannot be attained in isolation or without considering factors of the non-built environment. The built environment is comprised of manufactured structures (such as buildings and types of infrastructure), as well as the people who reside in them and how their needs and the natural environment shape those structures' design and use. All of these factors need to be viewed collectively as an environment in which people and non-humans live. By way of example, mere building retrofitting or adaptation in housing and settlements without considerations for construction cost, local construction skills, cultural appropriateness of settlement designs or governance capacity would not reduce climate and hazard vulnerability. Thus, the driving factors for vulnerability and thus

vulnerability reduction in the building sector, subject to in-depth research over the past 40 years, clearly shows that vulnerability reduction requires more than a technological fix.¹⁸⁻²⁵ It must also reduce deep-rooted socio-economic, environmental and political vulnerabilities (for example, existing policies, building standards and governance capacities).

TABLE 1. Vulnerability determinants in the built environment from a multi-disciplinary understanding (Author: Vahanvati)

Capital forms	Vulnerability Determinants	Natural hazards and climate events	Impacts
Physical (Spatial and Technical)	<ul style="list-style-type: none"> - Aging buildings and infrastructure - Limited defences to withstand/cope (e.g. vegetation, landscaping or water channelling for hazard reduction) - Inappropriate settlement layout and planning (density, evacuation paths, etc.) - Substandard building materials and quality of construction technology - Designed without consideration for passive design or climate friendliness and high resource consumption (not for adaptation) 	Buildings or assets located on fragile or hazard-prone environments, as: <ul style="list-style-type: none"> - Flood - Bushfire - Earthquake - Landslide or - Cyclone 	Damage or collapse of buildings and critical infrastructure, causing deaths (human and animal) and associated economic loss at individual and national scale and
Environment	<ul style="list-style-type: none"> - Stressed, degraded and fragile environment unable to provide a necessary buffer to hazards 	AND Exposed to or not adapted to climate change variabilities, as: <ul style="list-style-type: none"> - Sea-level rise - Humidity and rain changes - Higher temperatures - Evaporation changes - Wind changes 	further environmental degradation
Economic	<ul style="list-style-type: none"> - Limited resources, employment or income-earning capability at individual scale - Lack of government support - Security for contingencies (e.g. insurance or savings) for rebuilding 		
Social	Inequalities mean limited decision-making power, and they can be based on: <ul style="list-style-type: none"> - Gender (e.g. women, transgender) - Age and ability (elderly, children and disabled) - Migration status (migrant or refugee), - Ethnicity (e.g. Asian) or colour (e.g. brown, black) - Socio-cultural hierarchy (e.g. status, class, caste based) - Knowledge-based hierarchy (e.g. awareness or skills in safe construction technology) 		
Political/ Institutional	Inadequate or limited resilience strategies in the building sector, including: <ol style="list-style-type: none"> i. Planning policies, ii. Building codes and standards for resilience and adaptation, (e.g. key measures for specific hazard-types; codes informed by traditional construction technologies combined with modern science) iii. Investment in disaster preparedness, early warning systems, etc. iv. Public-private-partnerships for developing, assessing, implementing, and monitoring and evaluating robustness and policies 		

2.1.2 Poverty and/or affordability

Economic vulnerability is intertwined with the physical vulnerability of housing or settlements.²⁶⁻³¹ One of the pioneers in development studies, Robert Chambers,²⁶ confirmed the intertwined nature of poverty and vulnerability in the context of low-income groups. This means that disasters disproportionately impact the poor due to their lack of wealth or access to wealth, as well as their limited buffers or insurance against uncertain times. For example, people who have limited resources (savings, insurance, knowledge) and lack safe housing and legal land rights find it nearly impossible to rebuild and recover after a disaster without external assistance. Consequently, disasters are pushing an estimated 26 million people into poverty each year.³² Between 1998 and 2017, 70 per cent of global deaths and more than 80 per cent of overall economic losses were recorded in the developing countries within Asia and Oceania, as shown in [table 2](#).

Given the unequal distribution of disaster impacts, a global consensus has emerged on the linkages between poverty and vulnerability on development and disasters, reflected in broader policies and practices.³⁴⁻³⁷ Nevertheless, even those who have financial means to build or invest in safe housing and settlements may not necessarily do so due to underlying social and cultural values.

2.1.3 Gender and social discrimination

Social dimensions are a main determinant of vulnerabilities.³⁸⁻⁴² As shown in [table 1](#), social vulnerabilities exist in many socio-cultural forms – gender inequities, social hierarchies, cultural biases, caste systems or lack of supports for

those who are disabled.⁴² What may then follow is a lack of equitable access to markets and information or a loss of traditional knowledge about appropriate construction. This results in homes built with inappropriate or poor-quality materials, in under-serviced parts of town, or in areas such as floodplains - which have low economic appeal but a high risk of losses from disasters (e.g. floodplains).

Gender inequities magnify pre-disaster vulnerabilities during and after disaster. For example, in rural Bangladesh and India, women are expected to stay at home, which limits their movements and their access to information on floods and cyclones. Furthermore, women in those geographic locations typically wear a *sari* (a traditional long cloth, wrapped around the body), which hinders their ability to run and swim to escape floods or cyclones. Adding to this, girls are rarely taught swimming skills. In some parts of the world such as the Pacific and many parts of Asia, women do not own land, only their husbands or fathers do. If a husband dies during a disaster, his wife may be unable to prove land-rights, impairing her ability to rebuild. Women and girls in developing countries are particularly vulnerable to disasters for a combination of reasons including their differentiated roles (e.g. child-rearing, wood and water-fetching, cooking and cleaning), a lack of access to and control over assets (e.g. land), and a lack of financial and human resources and skills.⁴³ Subsequently, there is a growing emphasis on incorporating gender-based responses to disaster risk reduction in policies and practice.⁴⁴⁻⁴⁹ This emphasis is also found in building design which reflects and influences the gender power relations in a given society. Gender-responsive design of buildings contributes to gender equality and

TABLE 2. Relative human and economic costs of geophysical disasters on continents 1998-2017 (adapted from: CRED, 2018)³²

Regions	Disaster occurrence (%)	Deaths (%)	Affected (%)	Economic loss (%)
Africa†	6	1	1	1
America	19	30	13	10
Asia	62	69	85	78
Europe	8	-	1	5
Oceania	5	1	-	5

† It is important to point out that studies on African urban centres have shown that many events, such as urban floods, are not recorded as disasters in national and international databases, indicating that the numbers might be higher in reality.³³

women's empowerment and, therefore, resilience for all.

2.2 Adaptation and resilience in the building sector

The concept of "adaptation" is defined by the Intergovernmental Panel on Climate Change (IPCC) as the process of adjusting to the current or future climate and its related effects. Within human systems, adaptation aims to either avoid or minimize harm and to take advantage of beneficial opportunities. Related to adaptation is the concept of "adaptive capacity" which describes the ability of organisms, humans, institutions or systems to adapt to possible harm, take advantage of emerging opportunities and respond to impacts.⁵¹

The term "resilience" is used in a wide range of disciplines and can have a variety of definitions depending on the disciplinary framing of the term. Even in the building sector and at the building scale, the term resilience has multiple meanings. One common meaning of resilience is the ability of a building to keep indoor temperatures within

pre-set limits or to permit people to adapt to changing circumstances outdoors.⁵² More specifically, this includes the ability of a building to avoid overheating through passive (non-mechanical) design approaches including the use of shading, natural breezes and other approaches explored later in this report. For the purpose of this document, resilience in buildings is the ability of a building to meet the occupant's needs and provide for a safe, steady and comfortable use in response to changing conditions outside.⁵²⁻⁵⁵

2.3 Buildings and climate risks and impacts

The indoor environment of buildings acts as a buffer against an outdoor environment that is subject to environmental change and the potential for disaster. Buildings offer their occupants many things including protection; space for economic activities such as manufacturing and food production; and opportunities to foster human health and well-being, including education. Evidence from Malawi shows a 44 per cent reduction in disease among young children living in homes with flooring compared to

FIGURE 2. Cyclone Fani hits northeastwards into West Bengal state⁵⁰



A family waiting in front of their house close to Shibsra River when Cyclone Fani hits northeastwards into West Bengal state and towards Bangladesh. Khulna, Bangladesh. 3rd May, 2019.

those living in homes with dirt floors.⁵⁶ Thus, a home is intrinsically linked to human health, well-being and, now, climate risk reduction.

This section provides an overview of the main climate change-driven challenges and risks for buildings, including impacts from droughts, flooding, extreme precipitation and heat stress.⁵⁷ While severe storm events and devastating floods often make headline news and provide disturbing visual images, heat stress is also a significant threat to human well-being and life. All buildings, even those not at risk of flooding or harm from other natural disasters, face risks related to the long-term warming of the climate. Especially dangerous is the increased occurrence and intensity of extreme humid heat at levels exceeding human tolerance, which already is threatening livelihoods and settlements every

year.⁵⁹ Later sections of this report will outline how, through smart design and construction, buildings can serve as a key factor in improving their occupants' ability to survive storms and other disasters.

Figure 3, below, depicts the linkages of climate change drivers to the environmental effects of climate change, and how it impacts buildings and the people and processes within them.

People who lack access to essential services and infrastructure, or who live in vulnerable areas and low-quality housing, are further susceptible to potential risks. Alleviating issues related to poor services, infrastructure and housing has the potential to considerably reduce urban vulnerability and exposure.^{57,58}

FIGURE 3.

How the environmental impacts of climate change affect buildings and the people and processes within them (Image from: De Wilde & Coley, 2012)⁶⁰

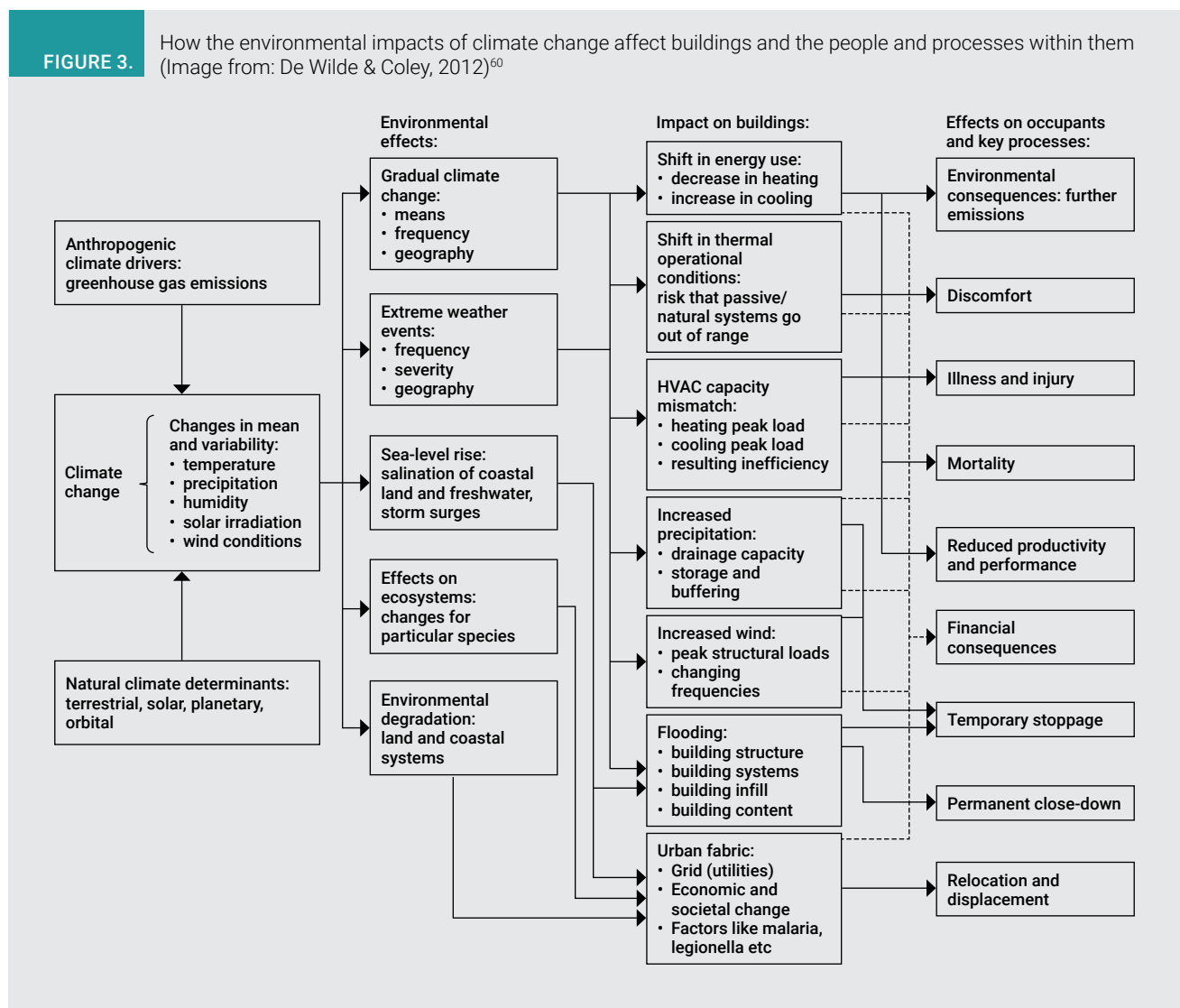

As explored above (see table 1), the vulnerability of housing and infrastructure depends on a number of factors, such as their design (making them more or less resistant to storms) or location (areas at risk for flooding, landslides, etc.). A plurality of climate change effects can damage or destroy buildings and infrastructure; these include sea-level rise, low or high temperature extremes, strong winds, heavy

snowfall, floods and extreme precipitation all pose different risks. The potential risks vary among regions, making it important to provide contextually specific and appropriate adaptation measures.⁶¹

FIGURE 4. Climate change impacts on buildings (from: Andrić et al., 2019).¹

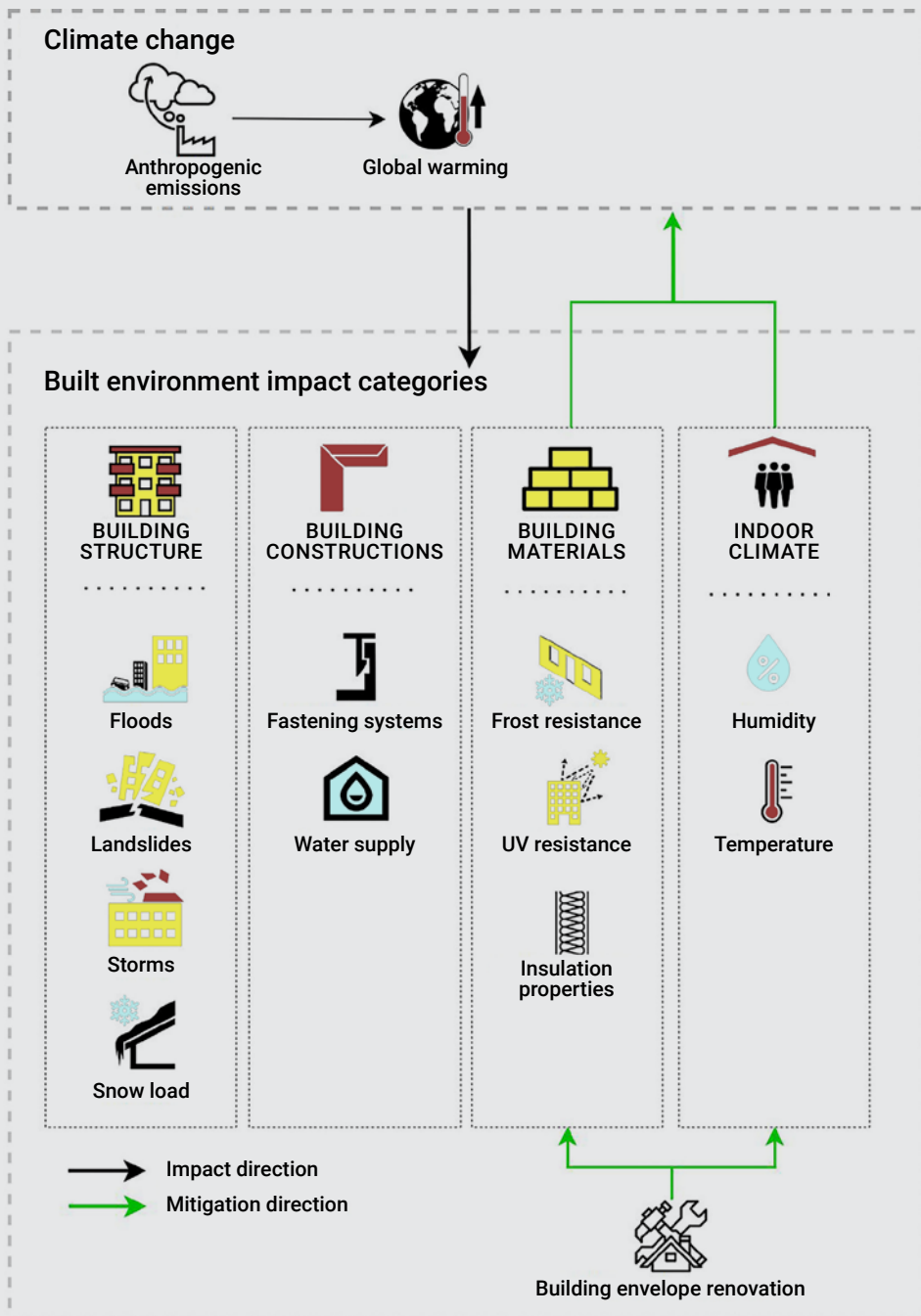

2.4 A warming climate, heat waves and droughts



2.4.1 Heat waves

Extreme weather-related disasters between 1995 to 2015 have caused 27 per cent of deaths[‡] with the vast majority due to heat waves.⁶³ With a changing climate, human society is predicted to witness an unprecedented intensity and duration of hot days as well as an increase in atmospheric humidity, both of which are bound to exceed human tolerance levels, posing new and alarming challenges.⁵⁹ This is of growing concern particularly for cities around the world, where buildings, impervious surfaces (roads, parking lots, etc.), and limited green space, are main contributors to the urban heat island (UHI) effect.

In 2019, cities across the world witnessed their hottest summer ever.⁶⁴ Research shows that UHI can add from 2°C to 4°C in urban areas compared to outer suburbs, and as much as 15°C compared to parklands or rural areas.⁶⁵ This substantial difference in temperature is caused by a number of factors, many of which are explored in this report, including urban design; materials with high thermal mass, low albedo and low permeability; insufficient green space; and more.⁶⁶ Mapping in St. Louis, Missouri, in the United States found the highest rates of heat wave deaths in inner city areas; population densities there were higher, green space was limited, and the residents were of lower socio-economic status. Similarly, rural and poorer populations in many developing countries may also be more vulnerable to heat waves and other climate risks as a result of inadequate housing and a lack of access to amenities such as clean water.⁶⁷

Lastly, buildings that rely on mechanical heating and cooling have enabled humans to live in vastly different climates – ranging from high to low temperatures – throughout the world. However, for people with low incomes who cannot afford electricity, poorly designed buildings (without passive design features) amplify the effects of heat and increase their occupants' risk of heat-related

illnesses. Without thoughtful design and planning the buildings themselves, including their materials and mechanical systems, can also be negatively impacted by a hotter climate. High poverty levels, lack of access to basic services and the informal nature of settlements further exasperate the impact and vulnerability in urban areas across developing countries.⁶⁸



2.4.2 Drought

Periods of drought occur all over the globe, with Africa being the continent most frequently struck.⁶³ In 2018 the city of Cape Town, South Africa, was forced to implement severe water-use restrictions, reducing overall use by over 50 per cent in an attempt to mitigate water shortages when dam volume hovered between 15 per cent and 30 per cent capacity.⁶⁹ In 2019, India faced the country's worst water crisis in history. The government estimated that 21 cities would run out of groundwater by 2020. The southern city of Chennai became the first, which experienced its worst drought in 70 years during 2019 when the four main reservoirs ran dry.⁷⁰

Droughts also lead to direct impacts on buildings. For areas with certain soil types, drought may lead to soil shrinkage, which causes vertical movements of the soil. This process, known as drought-induced soil subsidence, can significantly damage buildings and infrastructure (see figure 5).^{71, 72}

Further, drought and extreme heat can damage building materials, shortening their lifespan or even causing some materials to shrink and crack as moisture is lost. Droughts can increase fire risks for both structures as well as sites if proper care is not made to keep dry vegetation in check. Dry vegetation also a trigger for wildfires, a hazard that also has increased, especially in California and Australia, due to the hotter and drier conditions resulting from climate change.

In late 2019, for example, wildfires burned through approximately 18.6 million hectares of land in southeast Australia, destroying 6,000 homes.⁷³ It

[‡] It is important to point out that studies on African urban centres have shown that many events, such as urban floods, are not recorded as disasters in national and international databases, indicating that the numbers might be higher in reality.³³



took nearly 240 days to get the fire under control. The primary factor behind the increased fire risk was a prolonged drought followed by an intense heat wave. Wildfires, as was the case in Australia in 2019-2020, are about 10 times more likely to occur now as compared to 1900,⁷⁴ and they are predicted to get more severe with at least 30 per cent of them a result of climate change.

FIGURE 5.

Drought-caused soil subsidence impacting foundation and wall structure (Source: Håggström, 2020)

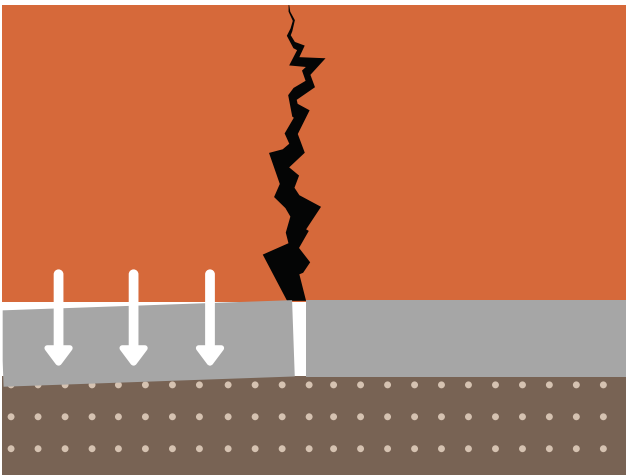

2.5 Storms, floods and sea-level rise



2.5.1 Cyclones and storm events

In March 2019, the Sofala province in Mozambique was struck by one of the worst-ever cyclones of the southern hemisphere. Cyclone Idai led to the deaths of hundreds of people, with nearly two million additional people affected. Homes, roads, bridges and a dam were washed away by flooding that was up to six meters high, causing devastation over a large part of the country (approximately 3,000 km²).⁷⁵ Mozambican former first lady Graça Machel, on a post-cyclone visit, declared Beira, the country's fourth-largest city, "will go down in history as having been the first city to be completely devastated by climate change."⁷⁶

Storm surges, cyclones and hurricanes led to the death of 242,000 people during the period from 1995 to 2015. This makes storms the weather-related

event causing the highest number of deaths. During this period, a total of 2,018 storms were recorded, making it the second-most frequent natural hazard after floods.⁶³



2.5.2 Sea-level rise

At the end of the century, sea levels will have risen on a global scale, meaning that the risk is universal.⁷⁷ Low-lying, densely populated coastal areas are especially at risk of storm surges and flooding coupled with sea-level rise. These events can have potentially disastrous impacts on communities, leading to halted economic activity, destruction of critical infrastructure and intrusion of salt water into freshwater sources. Infrastructure systems in coastal communities will face a plurality of risks as a result of sea-level rise leading to accelerated degradation and disruption to infrastructure networks such as power grids and transportation.⁷⁸

Small islands are especially vulnerable; there, sea-level rise will lead to destruction of coastal settlements and infrastructure, loss of livelihoods and ecosystem services, as well as disruptions to economic stability.⁵⁷ One example is the small island Batasan, the Philippines, which is now threatened by rising sea levels because a 2013 earthquake resulted in a loss of elevation. The example of Batasan also underlines the interplay between climate change-related hazards and other factors in natural disasters.

The combination of sea-level rise, soil subsidence and rapid urbanization is a lead contributor to the phenomenon of sinking cities, especially throughout Asia. Many of the largest and most rapidly growing cities are located near rivers and coasts where they are prone to this unique challenge. Cities currently struggling with this issue include Jakarta, Indonesia; Lagos, Nigeria; Dhaka, Bangladesh; and Bangkok, Thailand. Addressing this challenge involves a number of difficult trade-offs involving substantial planning, investing in infrastructure, and adjusting to the new reality brought by higher seas and a warmer climate.^{80, 81}

FIGURE 6. Water rescue crew on site searching for survivors after dangerous flooding⁷⁹

Aerial drone views high above flooding caused by climate change leaving entire neighborhood underwater and houses completely under water, boat with water rescue searching for people stuck in their flooded homes. USA, Texas, Austin, 2020



2.5.3 Flooding

There are many types of floods,[§] of varying nature and impact, and they are occurring more frequently. Between 1995 and 2015, floods affected a total of 2.3 billion people, making up 47 per cent of all weather-related disasters.⁶³ They pose a risk not only to people but also to buildings located in flood plains, with dense urban areas experiencing the most severe impact. Damage to buildings as a result of floods can be attributed to direct inundation as well as to a change in ground-

water flow and soil conditions.⁸² **Figure 7**, below, provides an overview of the types of damage to buildings.^{83, 84} Buildings in coastal areas are especially susceptible to damage from floods caused by higher than average tides, heavy rain and onshore winds.⁸⁵ Factors that affect damage include flood duration, sediment concentration, flow velocity and contamination. It is important to note that, except for depth damage, these factors are rarely included in flood-loss models.²

§ **River floods:** when water levels rise above riverbanks as a result of heavy rains, snowmelt or ice jam. **Storm surge:** abnormal rise in coastal water levels as a result of severe storm winds, waves, low atmospheric pressures, risk of inundation of large areas. **Inland flooding:** accumulation of moderate precipitation over several days, intense precipitation over short time period, river overflowing, levee failure. **Flash flood:** heavy rains over short period of time, often lead to powerful floods destroying riverbeds, streets, bridges, etc.



In summary, the effects of storms, flooding and sea-level rise on the built environment encompasses:^{86, 87}

- structural loading by pressure forces, leading to structural failure
- general structural failure of building components leading to potential for total building collapse and destruction
- impact damage from flying debris
- rain and moisture penetration leading to internal damage
- water damage to building contents (interior linings, furnishings, appliances, equipment and plant)
- possible contamination of interior of building from sewage, soil and mud
- undermining and/or destroying foundations, potentially leading to structural collapse
- salt spray (coastal) affecting material's durability
- loss or damage to property resulting from coastal erosion

FIGURE 7.

Division of damages to buildings caused by floods (Figure from Lamothe et al., 2005).⁸³

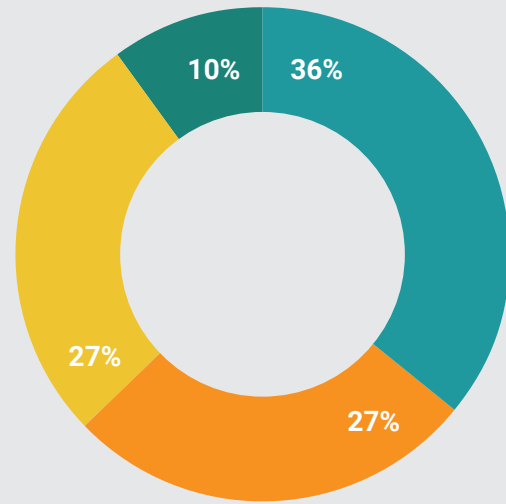

- walls, ceilings and their paneling
- floors and floor coverings
- heating systems
- electric installations and windows



3 General approaches and design principles

Resettlement village, Nakai Plateau, Khammoune Province, Lao PDR.

© Photo: Stanislas Fradelizi / World Bank

3.1 Overview

Our homes, schools and places of work and worship are nested in multiple levels from a home in neighbourhoods to communities, communities to towns and cities, and from cities to regions and countries. Buildings interact with these different levels of organization and are typically built with different time frames, or lifespans, in mind.

Homes are where we spend our day-to-day life and typically last ten or twenty years before needing repairs or upgrades. They tend to be built as populations settle and are abandoned as they move. Schools are focused on the education of generations of students and, like office buildings, are typically built to last multiple decades, providing an anchor to a community, and creating a space for gathering and communal interaction. Municipal, cultural and religious buildings can be key landmarks, fixed in place for the long-term, and establish an important sense of identity for the community, serving residents for multiple generations.

Understanding how the different building types and uses shape the identity and lifespan of parts of towns and cities can assist in planning for climate change. This is because climate change adaptation and resilience to risks is not a static state but rather a continuous, ongoing series of activities. Actions taken to improve the resilience and reduce vulnerability of the built environment and communities can be grouped into three key phases of time: 1) prior to the event; 2) during the event; and 3) long time after the event.¹⁴ All three phases can play a role in building resilience. For example, preparing a school or home prior to an anticipated hazard (phase 1) like a heatwave, by following steps such as planting shade trees, will reduce heat gain and improve cooling of a building during the heat wave (phase 2). A more immediate impact can be achieved by improving the selection of building materials, structural design and building techniques (such as anchoring walls to the foundation) to mitigate risk during a disaster. The work needed to lower or eliminate vulnerability of at-risk populations to hazards will also require addressing longer-term systemic issues such as poverty, equity, gender and access to knowledge and education.

This report primarily focuses on the first two phases – actions taken prior to an event and those that help during a disaster event. The report first presents larger-scale interventions followed by general architectural design and construction approaches that can help to improve a building's resilience and resistance to disaster. Taken together these interventions, when filtered through local needs and conditions, can be applied to all building types.

3.2 The role of institutional policy frameworks in adapting the built environment

3.2.1 Political will and capacity

Leading the way in disaster risk reduction and climate change adaptation in the built environment are a number of grass roots community groups and international organizations including UNEP; United Nations Development Programme (UNDP); International Federation of Red Cross and Red Crescent Societies (IFRC); United Nations Human Settlements Programme (UN-Habitat); among others. The national government and policy makers hold the most important responsibility and have the power to plan, influence and implement changes necessary for vulnerability and disaster risk reduction.²⁵ Studies on famine have found that the vulnerability of farmers was not linked to the limited availability of food; rather, it was linked to the underlying lack of institutional interventions such as the inability of farmers to barter their entitlement of labour for food.⁸⁸ This finding exemplifies that political will can avert a hazard from becoming disastrous by putting the right strategies in place.⁸⁸ Research in India on post-disaster housing reconstruction confirms the significance of political will in setting the tone of reconstruction policies (such as owner-driven or agency-driven) and governance set up (centralized or decentralized governance, public-private partnerships).⁸⁹

3.2.2 Building codes

The development, application and enforcement of building codes is a potential solution for incorporating safety, environmental and other measures into the built environment. Codes can dictate how buildings are constructed, which materials are used, how much energy or water is consumed, and whether it is designed to reduce vulnerability. Typically, building codes use historical climate data to predict issues that may occur during the life cycle of buildings. However, it is now imperative that new buildings are designed to be adaptable to a changing climate, so new building codes should also include estimates of future warming. Studying past extreme weather events and their impacts can also help in developing new building codes. For example, Canada used historical evidence from the 1985 Barrie tornado outbreak and found that many of the damaged homes were not tornado-proof due to the lack of anchorage (see section 5.3.2 in chapter 5). This was then implemented and included with modifications to the Canadian Standards Association specifications for construction.⁹⁰ Unfortunately, current scarcities in climate data or poor-quality data in many parts of the world can make it challenging to update building codes. But some countries are trying. The United Kingdom is incorporating aspects of climate change adaptation into their building codes and standards.

United Kingdom:

The national adaptation programme describes the government response to the Climate Change Risk Assessment (CCRA) as an adaptive and resilient approach to climate change.⁹¹ The key risks identified in the CCRA 2017 are:

- Risk to health and well-being from overheating and extremities in weather
- Risk to communities and buildings from flooding
- Risk to coastal communities from sea levels rising
- Risk to health sector from climatic changes

The Adaption Sub-Committee (ASC) recognizes that there are no building regulations that address the risks to health from overheating, and that there is no process by which to approve and adopt Sustainable

Drainage Systems (SuDS) (see section 4 in chapter 3). The lack of regulations coupled with the absence of approval processes results in frequent delays in addressing the identified short-comings of resilience to flooding and heat-waves in health sector buildings. (Communities and Local Government, 2010). Present building regulations have guidelines to deter overheating in new homes; however, these are not based on climate change concerns or the well-being of residents, and exclusive regulations related to health and well-being due to overheating are non-existent.^{92, 93}

Developing Countries:

The status of building codes in developing countries is significantly diverse, but efforts to introduce building codes (both mandatory and voluntary) have been increasing. However, 60 per cent of African countries and 35 per cent of Latin American countries lack any regulations.⁹⁴ In contrast, energy building codes are fairly widespread in Southeast Asia and are established in China, Hong Kong, Indonesia, Japan, Republic of Korea, Malaysia, Philippines, Singapore, Thailand and Vietnam.⁹⁵ The challenges for developing and implementing building codes in developing nations are: lack of good quality data; lack of awareness of energy efficiency; and insufficient building code expertise or enforcement. Overall, the climate adaptation regulations in building codes are inadequate in developing countries, and much work needs to be done in this area.

For building codes to successfully reduce vulnerability, they should be well-designed and include all of the following features:

- Consider future warming and other climate changes (precipitation, etc.).
- Offer avenues for broad dissemination, enabling builders, architects and product suppliers to learn – and consequently apply - the new building requirements.
- Require enforcement by thorough inspections of the design and construction of buildings.

This requires some substantial capacity-building and the development of governance systems (permitting, inspections, fines, etc.) which may not be immediately implementable in the target

areas for this practical guide. There are a number of excellent resources available online that provide updated information on the status of building codes, good examples of such regulations and related information. See [chapter 7 on additional resources](#) at the end of this report for some of these links.

3.3 Design and construction principles

This section explores the broader design and construction principles and owner-driven or agency-driven approaches that can be applied or considered in any building project.

3.3.1 Human-climate-building interactions

Occupant behaviour complicates the interaction between the building and the climate. The traditional three-way interaction between climate, people and buildings dictates energy needs (see [figure 8](#)).⁶⁷ Buildings provide a level of comfort in order to cope with the climate; in addition, people control elements of the building to improve their comfort further. Energy use is influenced by climatic, social, economic and cultural contexts. The adaptive principle is essentially the human response within the building. That is, if a change occurs such as to produce discomfort, people react in ways that tend

to restore their comfort.⁶⁷ Furthermore, there are many physiological factors that impair temperature regulation (with respect to thermal conditions) and also the ability to responsively adapt to a specific threatening scenario. As an example, age and illness are strong predictors of heat- or cold-related sensitivity and inability to adapt.⁶⁷

Consideration should be given to a building occupant's ability or interest in using, or not using, any of the design approaches outlined in this report. Building occupants need not only to understand, but also to choose, use and maintain the approaches identified. Without the occupants' awareness, consultation and adoption, many of these measures will not provide the desired results.



3.3.2 Owner-driven reconstruction for adaptation

Owner-driven housing reconstruction (ODHR) can offer an alternative to a more formal method of managing building design and construction, such as through building codes and formal permitting processes. ODHR is defined as a process in which

FIGURE 8.

Dynamic three-way interaction between climate, people and buildings dictates energy needs in buildings (from: Nicol et al, 2012)⁹⁶

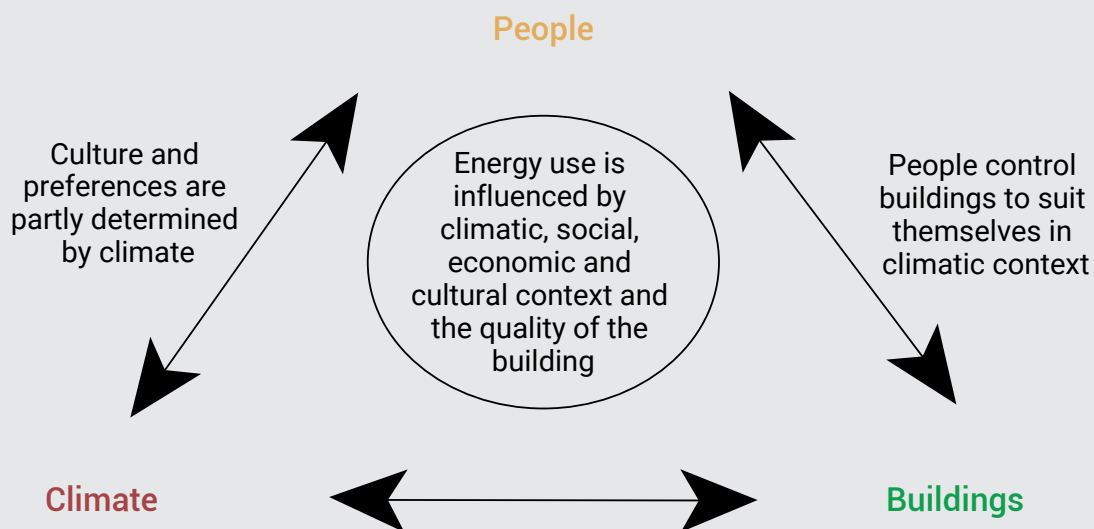

“the residents (house owners, renters or squatters) are enabled to have authority or decision-making power throughout the entire [reconstruction] process and this is made possible by the enabling policy framework and practice of the government and civil society organisations, respectively.”⁸⁹

This definition emphasises “enabling” of disaster survivors to make informed decisions with support from civil society and government. Thus, ODHR, “by itself does not necessarily lead to a sustainable built environment or to resilient communities,”²⁰ rather, it demands more from the government authorities, civil society organizations and the private sector – all to be proactive, collaborative and effective enablers – to mobilize communities to make informed decisions for themselves.

ODHR has become the preferred option and is actively promoted by a host of international organizations.⁹⁷ For example, UN-Habitat and the World Bank promoted ODHR approaches after the 2004 Indian Ocean tsunami and the 2005 Pakistan and 2010 Haitian earthquakes.³⁷ India and Bolivia were among the first two countries to adopt ODHR as a national policy framework for post-disaster reconstruction at large scale.⁸⁹

Increasingly, there are examples of owner-driven approaches adopted in anticipatory adaption work in the built environment. For example, as part of the Honiara Urban Resilience & Climate Action Plan project, the researchers conducted climate vulnerability assessments for five settlements in Honiara in a collaborative manner.¹⁶ Given that community in Honiara is place-based and has deep cultural values, the entire process from social profiling to vulnerability assessment to needs identification and resilience solutions was co-produced with community and other stakeholders. This vulnerability assessment revealed that the city is exposed to multiple natural hazards, which a changing climate will amplify, and also that nearly 40 per cent of housing stock in Honiara is informal and was built by its residents. This required developing a holistic, multi-hazard approach (coastal inundation, flooding and landslides) and a suite of measures for implementing climate resilience actions. Some of these measures incorporated a risk analysis based on data gathered by geographic information systems (GIS). This information informed the scale

and design of settlements in order to reduce the flow and strength of streams to avoid landslides; plan “no build” areas; relocate at-risk settlements; improve access to evacuation centres; upgrade existing housing; and develop shelter design and construction guidelines.¹⁶

The benefits of ODHR are many, and they can be summarized as being speedy; less-expensive (as survivors salvage materials for their own housing reconstruction); and the most dignified and empowering approach to reconstruction.^{20, 98-100} ODHR can also potentially embed the safe building and construction technology in the local culture and local livelihoods.^{98, 101}

Marrying ODHR with the adaptive and resilient approaches identified in the next section could help to unlock greater capacity and action among at-risk populations leading to an overall reduction in vulnerability.^{98, 102, 103}



3.3.3 Frangible architecture or “planning for damage”

Frangible architecture is the intentional design of walls, roofs or other structures so that they give way in face of high winds, flood-waters or other extreme events. This approach can help to mitigate overall damage to a building and aid in the protection of life and property. It is a strategy that use several approaches, such as the one described in the “House-within-a-house” case study below or the roof construction detail outlined in [figure 45](#) (see section 5.3.1 in chapter 5). In the example of an area prone to flooding, a non-essential space on the ground floor, for example a storage area, would be designed with walls that are not completely secured to the remaining structure. When there is high water, the walls give way and allow floodwaters to flow unobstructed below; this prevents additional structural damage to the remaining portion of the home or commercial building. Similar approaches can be adopted with regard to high winds and roofs over non-essential spaces, balconies or patios.

FIGURE 9. House-within-a-house is an approach that provides for a high-wind resistant core inside a home which can withstand extreme winds. Surrounding the hardened core is a perimeter that is conventionally built. This strategy allows for more affordable dwellings that can be built in phases, giving families an opportunity to have both a place of safety for retreat during extreme weather-events and a home that is aesthetically appealing and expandable as needs change. A prime example of this is the award-winning “CORE House” by Q4 Architects. This approach does require architectural and engineering services as the building’s orientation, openings, and other features need to be carefully planned to ensure they withstand high winds.⁴

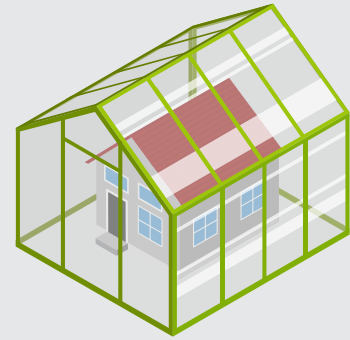

3.3.4 Triage design for rapid reconstruction after disasters

Applying a “triage” approach to how buildings are designed and constructed can allow for ongoing use and/or quick repairs after a hazard event. Ensuring the core building structure is strong (see frangible architecture) and designing mechanical, electrical and plumbing systems modularly so they can be isolated from damaged portions of a building allows some of the structure to remain functional. This can include having separate electrical or plumbing systems for different areas of a building. This added flexibility can allow for some of the facility to remain useful for the community as needed while repairs are carried out. Additionally, some key public buildings can be designed with mechanical, electrical or plumbing systems with added capacity in order to provide needed emergency services (toilets, power generation, cooking, heating or cooling, etc.) to temporary structures or housing after a weather event.

A longer-term “triage” approach includes designing for ease of reconstruction or even deconstruction of a building so it, or the materials at a minimum, can be used in another location. Design for deconstruction or reconstruction can be helpful, as rising water levels encroach (slowly) or unexpected events require movement from a location as the climate changes. However, creating a structure that is easily disassembled means that some of the materials and methods may not be fit for areas at high risk for structural damage through events including strong storms and hazards unrelated to climate such as earthquakes.

Design for Deconstruction (DfD), sometimes called Design for Disassembly approach, requires that every component of a structure have the potential to be reused or recycled using existing recycling streams. An important aspect of DfD is the longevity of the materials. There are many temporary structures built to be disassembled and transported, but few are designed to last.¹⁰⁴

*Selected DfD principles:*¹⁰⁵

- *Design for prefabrication, preassembly and modular construction:* Prefabricated units are easily deconstructed and can be transported in large units. Additionally, modular construction materials allow for large quantities to be transported in one journey.
- *Simplify and standardize connection details (screws, bolts, nails, etc.):* This allows for efficient construction and deconstruction and reduces the need for multiple tools.
- *Simplify and separate building systems:* Separating out the distribution systems within non-structural walls can allow for selective removal of the low-value components. Consolidating plumbing services will also reduce the lengths of pipe required.
- *Minimize building parts and materials:* The design should aim to minimize the amount of building materials and equipment required.
- *Select fittings, fasteners, adhesives, sealants and other items that allow for disassembly:* Minimize number of fasteners to cut down on time for removal; minimize different types of fasteners to reduce time needed in changing tools; use easy-to-remove fasteners; and fastener points should be easy to access to speed up disassembly process.¹⁰⁶

- *Design to allow for deconstruction logistics:* Small design tweaks can allow for significant improvements in waste-removal efficiency.
- *Design with reusable materials:* Consideration of materials that are adaptable and will be useful in the future. Materials such as wood, steel members, brick and carpet tiles can easily be reused or refurbished.
- *Design for flexibility and adaptability:* The design should consider any future renovations or adaptations that may be required to extend the life of the building.

The *KODA House* (see [figure 10](#)) designed by Estonian company Kodasema has created a modular moveable dwelling to provide affordable housing. The dwelling includes the amenities of a modern residence: a living area, bedroom, kitchenette, bathroom and occupies only 26 square meters. The house is built off-site and delivered as a whole - turn key, there is no assembly on site. After connecting to utilities, the house can be occupied immediately. Erection requirements include a level footing, e.g. supports of concrete blocks or otherwise and connection points for water, electricity and sewage.¹⁰⁷ The *KODA*, is in a way a repackaging of a traditional pastoral approach to housing but in this context it is intended to provide for affordable housing for growing populations.

Factory constructed houses such as *KODA* leave a smaller footprint in terms of transport pollution, worker safety, reduced construction waste and urban noise. A building that can be uninstalled, moved, and re-installed can provide communities with more flexibility to relocate as needed when faced with disasters and a changing climate. People's mental and physical well-being increases significantly when having the sense of community and belonging in a healthy and safe environment.

3.4 Nature-based adaption for design and construction



The vulnerability of an individual building is greatly influenced by its broader context. Is it built in a floodplain or steep hillside prone to landslides and erosion? How is the community or town addressing broader infrastructural needs such as land use and the handling of stormwater? An increasingly common approach to mitigating risk to hazards is through nature-based solutions (NbS) tied to green infrastructure (sometimes called low-impact development).** These community- or city-scale approaches often require broad interventions by a

FIGURE 10. KODA house (Image sources and more information kodasema.com)

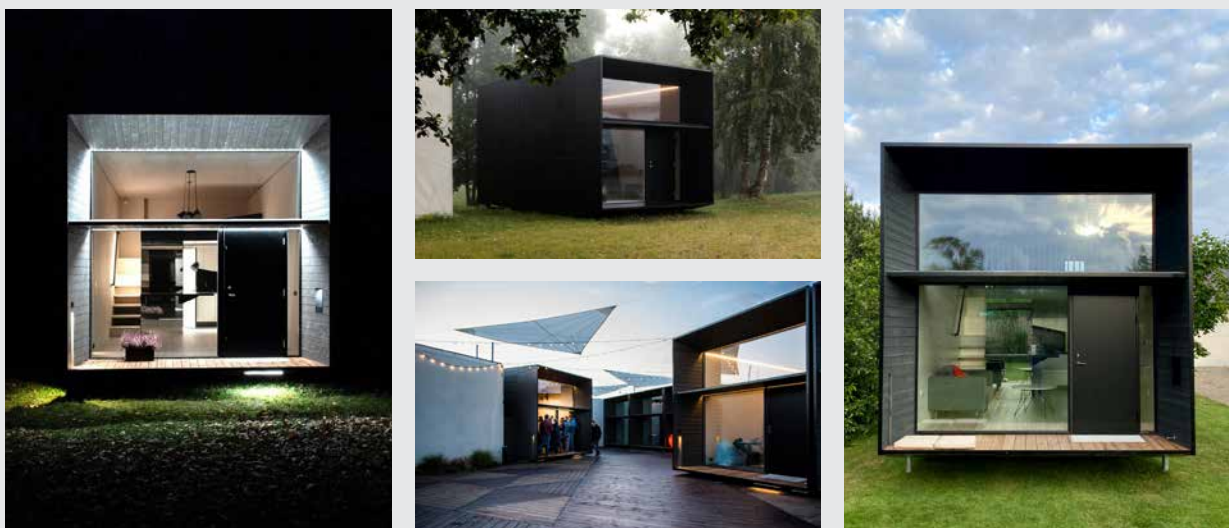

** **Low-impact development** describes a land planning and engineering design approach to manage stormwater runoff. It is an example of green infrastructure.

town (storm water treatment) but can be greatly assisted through building-scale interventions, such as collecting rainwater from a roof or planting trees and adding greenspace. In addition to their contributions to a reduction in vulnerability, these interventions have broader co-benefits as well, such as improving biodiversity, increased health and well-being of residents, and improving air quality, among others.

Green infrastructure (GI) is a “nature-based solution”^{††} that uses natural methods for the provisioning of some city services, such as those related to storm mitigation, water treatment and passive cooling. It plays an increasingly important role in improving the sustainability and liveability of cities and offers a way for municipalities to provision services, including protection, for a lower cost than the more traditional grey infrastructure. When included in buildings, GI can mitigate climate risks through, for instance, assisting in thermal regulation by providing cooling effects or reducing drought and floods through increased soil water retention and absorption.

Blue infrastructure is also effective in reducing the effects from an urban heat island (UHI) resulting from warming climate and more frequent heatwaves. The surface temperature of water is lower compared to vegetated areas which, in turn, are markedly cooler than streets and roofs. This means that there is a larger cooling effect per unit area of surface water as compared to a built environment or vegetated park system. This effect varies with time of the day.¹⁰⁸ Blue infrastructures include ponds, wetlands, rivers, lakes and streams, as well as estuaries, seas and oceans. Because water and land come together in multiple ways, including riparian areas, beaches, wetlands, and more, combining green and blue infrastructure is gaining attention in both research and practice.¹⁰⁹

In the context of disaster risk reduction and climate change adaptation, GI practices can help reduce the risk of **flooding**. Those practices include the use of porous pavement; green roofs; rainwater collection systems (cistern, barrel, etc., along with bioretention in vegetated swales); constructed

wetlands; and rain gardens. If well-planned through spatial analysis, many of these measures can also contribute to an improved microclimate for residents which, in turn, can reduce heat gain on dwellings and low-rise buildings as well as provide cooling through evapotranspiration and shading. This mitigates risks during **heatwaves** and also can lead to improvements in the well-being and health of residents. Additionally, many of these measures can provide habitat and improve biodiversity, mitigate air pollution and dust-reduction, improve ground and surface water quality by reducing non-point source pollution, and increase water retention by facilitating on-site percolation and absorption.^{110, 111}

Applied at the building scale, the most common GI and other nature-based solution options for climate change adaptation are listed below. Several of these approaches are explored in further detail later in this report.

- Collect rainwater in barrels or cisterns, and then use it to offset water use in toilets as well as irrigation and cooling systems. This, consequently, will reduce the impacts of flooding and drought/heat waves (see [figure 33](#) and [figure 34](#)).
- Create vegetated roofs to absorb rainfall, provide additional insulation and extend the life of a roof.
- Install porous paving and reduce the scope of hard surfaces in driveways and walkways, thereby reducing storm water run-off (see [figure 35](#) and [figure 36](#)).
- Build vegetated swales or rain gardens (also known as SuDS) to collect rain from roofs and other hard surfaces. This allows for on-site infiltration, which lessens the need for the kinds of hard infrastructure that normally would assist with water management and related tasks, and also can reduce flood risk (see [figure 12](#)).
- Plant trees, which can shade dwellings, and control dust and help to improve infiltration of storm water (see the next section).

^{††} The European Commission defines **NbS** as “solutions [to societal challenges] that are inspired and supported by nature, which are cost-effective, simultaneously provide environmental, social and economic benefits and help build resilience. Such solutions bring more, and more diverse, nature and natural features and processes into cities, landscapes and seascapes, through locally adapted, resource-efficient and systemic interventions.” (<https://ec.europa.eu/research/environment/index.cfm?pg=nbs> accessed 11 May 2020)

FIGURE 11. Urban morphological map of Addis Ababa, Ethiopia (Cavan, 2014).

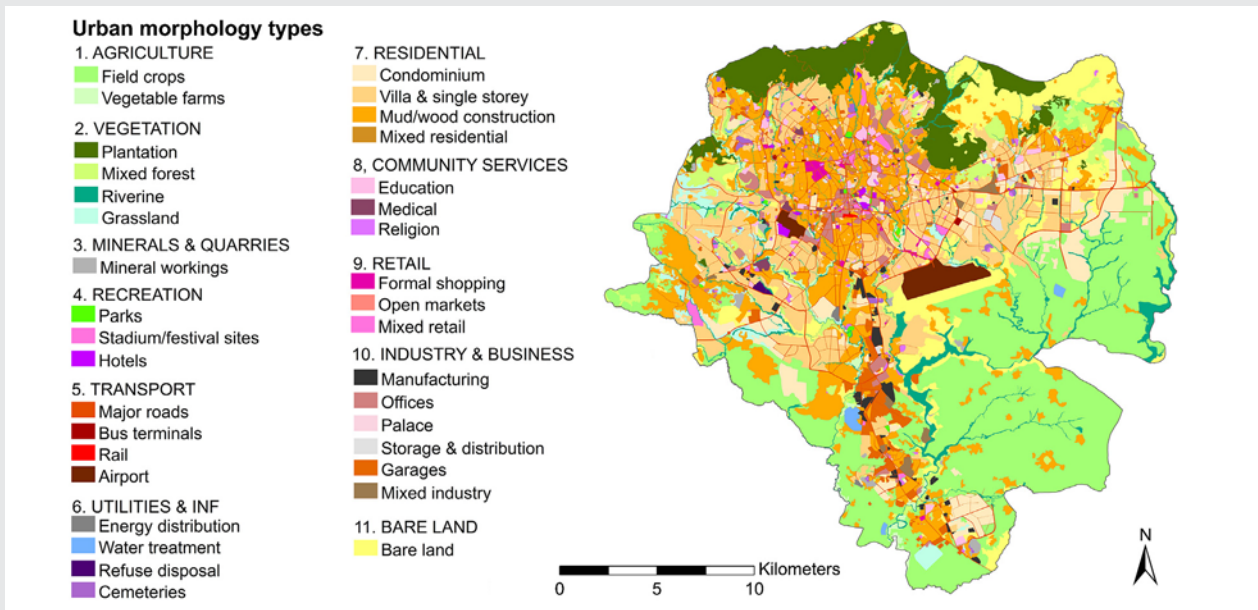

An analysis of two African cities found that surface temperature is influenced by the type and location of green space, housing form and material, and the overall urban morphology. When these factors are not well-suited, residents experience surface temperatures well beyond those anticipated by the warming climate. When buildings, green space, and neighbourhoods are appropriately designed and maintained, urban areas, including those with high-density housing, allow for manageable surface temperatures even in face of future warming. This approach speaks to the need to carefully select building materials, properly orient buildings, as well as ensure for quality and preservation of green spaces in cities and neighbourhoods. Without these efforts human settlements run the risk of becoming uninhabitable with surface temperatures exceeding thresholds necessary to sustain human health and well-being.

FIGURE 12. Components of a Sponge City (Yinxue, 2017).⁸



"Sponge City" is a green infrastructure approach which combines low-impact development methods such as pervious paving, bioretention, rainwater collection or other lower cost measures. When planned at an urban scale, these nature-based solutions can help to mitigate runoff and flooding, improve water quality and recycle rainwater for on-site use. Though many of these measures are well-suited for low-cost implementation, they do require coordination and careful planning, including knowledge of local soil conditions, to maximize benefit at the city or community scale.³



When thoughtfully designed, implemented and maintained, these measures may also improve livelihoods and enhance the nutritional status, health and well-being of residents.³ If an NbS is not properly positioned, it will do little to mitigate extreme events. As an example, coastal cities need coastal wetlands physically located between them and the sea if wetlands are to provide resilience to coastal storm surges. An NbS is not just a tool but is also a complex, living system. Functioning ecosystems interact with the larger social-ecological systems in which they are embedded and have their own vulnerabilities and resiliencies. The survival of the NbS over time also has both ecological and social aspects.¹¹²

Green infrastructure adaptation measures, like NbS, can provide numerous co-benefits or

“synergies” as mentioned earlier. However, many of these approaches need to be carefully planned, while others have some trade-offs that will need to be considered. For example, an evergreen tree (one that does not drop its leaves in the winter) that is planted for improving soil stabilization will reduce solar gain in the winter when it is needed to help warm a home. One trade-off in areas with high winds and increasing storm risk is that shade trees could fall and damage buildings or local infrastructure. Another challenge, if not carefully planned and managed, is with green SuDS such as swales or green flood zones; although they can increase biodiversity, they can also provide habitats for mosquitoes. Mosquitoes can also be a problem in rainwater collection tanks if they are not installed with protective material or are not maintained regularly.¹¹³



4 Adaptation ideas for thermal regulation and comfort

This chapter highlights design concepts and approaches that can be considered for mitigating risk related to the warming climate, including increased temperatures and more frequent extremes of hot and cold. They are presented here in the hope that architects, engineers, and other professionals will expand on these solutions and tailor them to local conditions. Consideration should also be given to the availability of skilled labour; the extent of known information (does the specific community have good geologic data on soil type, depth to bedrock, etc.); the availability of materials and tools; and the ability of local manufacturers to meet the demand for using new methods, such as the manufacture of metal fasteners for wind-resistant roof construction.

Climate hazards and impacts are regional, and priorities can vary depending on the social and economic conditions in the region, as well as how future warming will impact the design decisions made today. For example, in northern Europe there is a drive to achieve net-zero greenhouse gas emissions in the building sector. But as climate models project increased warming in the region, there is a concern increased insulation and airtightness (through the Passivhaus design standard and similar approaches) will result in overheating, coinciding with the effects of a warming climate. In the case of net-zero, mechanical solutions like air conditioning can be counter-objective, leading to greater localized urban heat island (UHI) effects as a result of the additional heat being expelled into the community from the cooling equipment.¹¹⁴

Housing projects greatly benefit from utilizing climate data for future warming trends in energy modelling. This enables better design and selection of materials -ensuring a long, active life for new buildings. A study of social housing developments in Brazil found that though they are expected to last 50 years their designs and systems will be insufficient to meet occupants' thermal comfort in the coming decades. Adaptation to climate change and planning for future climate projections should be considered in housing projects/at construction stage.

(Triana, Lamberts, & Sassi, 2018)

The examples in the following sections are grouped by different climate types and different risks. [Table 7](#) in the conclusion provides a summary table that lists the adaptive approaches by climate change impact. Additional technical information can also be found in the section on materials.

4.1 Building site and orientation



To adapt to increasing temperatures and to mitigate overheating, a building's performance can be significantly impacted by where on a site it is placed. Existing or planned elements, such as trees and other buildings, can provide shading or adversely block the sun when it is needed. Strategically planted vegetation on site can also capture and direct wind flow for natural ventilation (see [figure 13](#)). Directing prevailing wind towards the building is one way to achieve relative "coolth"[‡] through ventilation in habitable spaces.

To optimize the orientation of a building, designers must consider elements that are already on the site and the building site's relationship to the equator - which determines sun angles and affects orientation.

For passive solar design, the building must have the appropriate orientation of openings and spaces to achieve maximum daylight with maximized or minimized heat gain, which depends on the location and season. Generally, buildings benefit from orienting windows and openings within +/- 15 degrees from equator. Buildings should be oriented

[‡] Coolth –(noun) the state of being cool.

FIGURE 13. Plant trees and shrubs to funnel breezes (Image from : Reardon and Clark, 2013)¹¹⁵

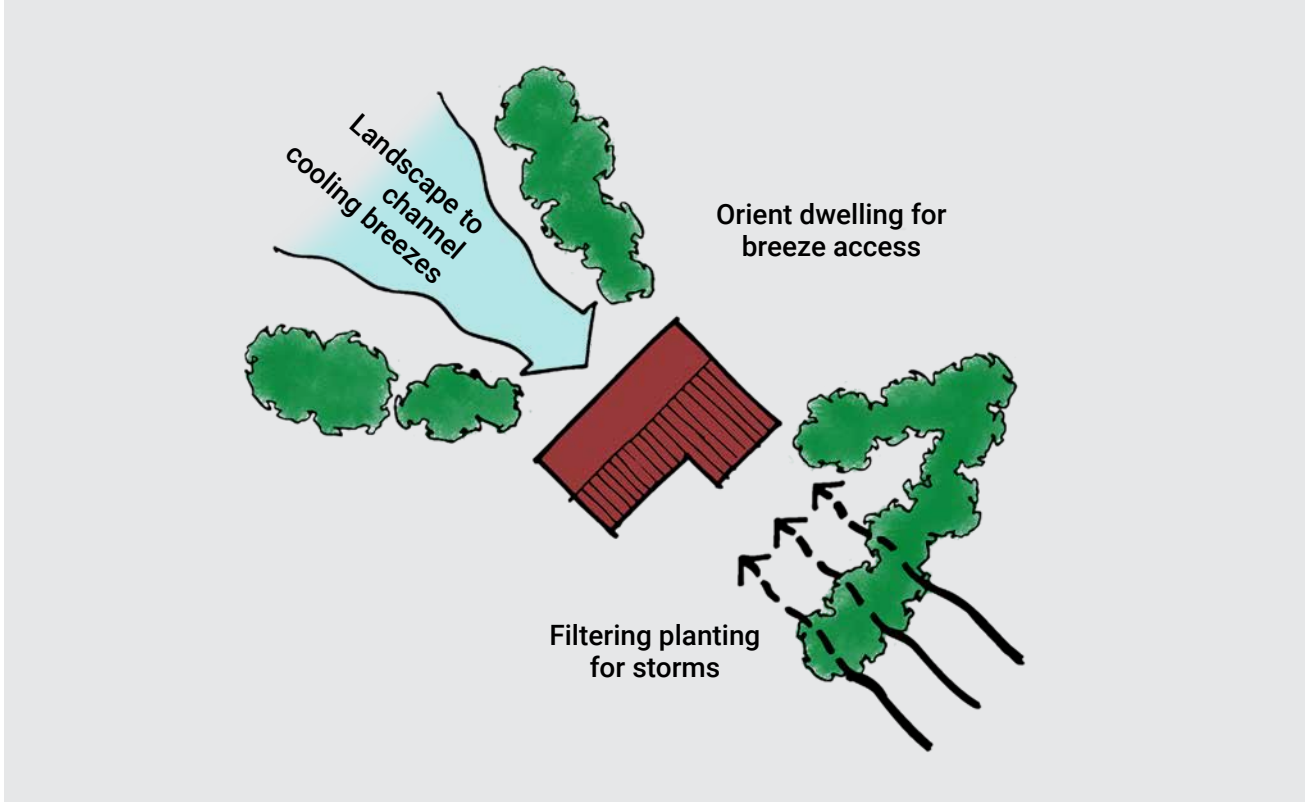
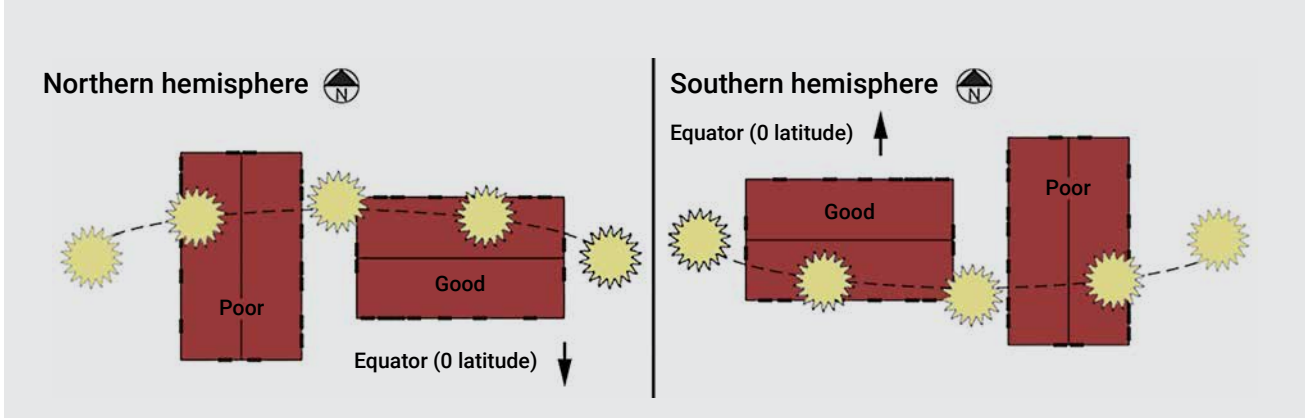

FIGURE 14. Ideal orientation of a building in both hemispheres (Image adapted from: Rupperta, Millera 2015)¹¹⁷



with their longest axis oriented in an east-west direction. This means the longest walls face north-south and the shortest walls face east-west, which maximizes light and also allows more control over the heat gain from solar exposure on external walls (see figure 14). In the northern hemisphere, the high sun angle in the summer on the south side is easy to shade, while the low sun angles on east and west side are not. In the south, this is reversed; with the high sun angle in the summer on the north side is easy to shade.

In areas prone to **cyclones**, there can be trade-offs between maximizing location and orientation for natural ventilation and passive design on one side and what may be best for minimizing risk during storm events on the other. Careful consideration is needed with regard to location, orientation, size and similar factors, although financial constraints may restrict options.¹¹⁶ If location decisions are limited and cyclonic areas cannot be avoided, raising the house above flooding level (where applicable) and structural strength are the only other options.

FIGURE 15. Low perimeter to area ratio (left) and high P/A (right) illustrated (Image redrawn from CLEAR).¹¹⁸

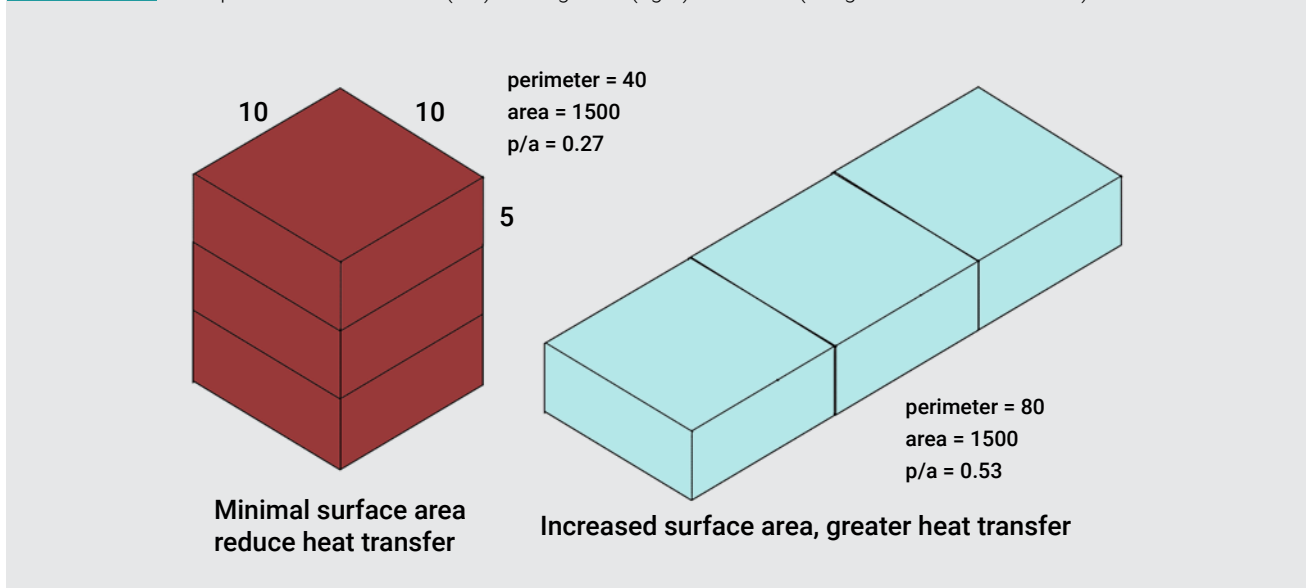

Sections 5.2 and 5.3 in chapter 5 contain additional recommendations for how to site and layout a building in cyclonic areas.

In **hot and arid and hot and humid climates**, in addition to building orientation, the amount of heat from the sun can be minimized by making the building compact and using heat-reflecting exterior treatment on the walls. Arranging multiple buildings to benefit from mutual shading minimizes solar exposure on vertical surfaces during summer months. Mid-rise buildings are optimal in terms of footprint area, shading and total energy consumed. Row housing is also advantageous, as solar gains are reduced due to common walls. Both of these approaches minimize the ratio of the building's perimeter to the area inside. A smaller perimeter-to-area ratio (P/A) results in less area exposed to solar radiation (see figure 15). Plans with greater P/A ratio may be applied in certain cases to include features such as courtyards, water bodies and vegetation, all of which can modify the microclimate.

In **hot and arid climates**, the P/A ratio should be as low as possible to minimize heat gain (from sun shining on surfaces). In **hot and humid climates**, although there is a need to minimize heat gain on the surface, there is also a need to create airflow through spaces. This might not necessarily lead to the need to minimize the P/A ratio.¹¹⁸

4.2 Building configuration and layout



Where rooms are placed inside a building, known as layout, can also provide benefit for thermal comfort. For example, in **cold climates**, main rooms should either be south-facing (in the northern hemisphere) or north-facing (southern hemisphere), to capture as much solar gain (and thereby, warmth) as possible. In **hot climates**, the opposite can be done to reduce the heat gained from sun during the day. If it is not possible to orient this way, other measures, detailed later in this report, can be taken to protect from solar gain.

Seldom-used rooms and those that typically have few windows - such as closets, bathrooms, utility or storage rooms, stairs or attached sheds and garages - can act as "buffer areas" on the east and west sides of the home, which receive direct sun in the morning and afternoon. This can help to keep heat out of the primary living areas. An example of this strategy can be found in Vietnam where homes are adapted to high amounts of sunlight. There, the typical traditional buildings are oriented facing south and now have a recommended room arrangement of stairs, bathroom and storeroom facing west, which protects the main rooms from direct solar gain.¹¹⁹

4.3 Natural ventilation



Both the building's orientation on the site and the building's internal configuration can be designed to take advantage of cooling breezes. The prevailing wind direction should be considered when deciding the building orientation on the site to allow for optimum positioning of windows and to maximize natural ventilation whenever outside temperatures are low. When outside temperatures are high, windows and openings are closed to keep the indoor temperature cool.

Building forms with shorter depths can facilitate cross-ventilation throughout the building (useful in **hot and humid climates**) (see [figure 16](#)). In

Vietnam, to adapt to high average temperature and humidity, room height is 3.9 m to 4.2 m. and many large openings are used to improve ventilation.

Depending on the location, houses and other buildings can be clustered for beneficial or detrimental passive efficiency. The Juanapur housing resettlement in New Delhi, India, (see [figure 17](#)) used a cluster design to provide shading and mass but allowed for the prevailing wind to flow through the cluster to provide cooling to the units.

Directing prevailing wind towards the building is one of the best ways to achieve relative "coolth" in habitable spaces. The process of redirecting the wind flow from a larger catchment area to a smaller one will convert high pressure, low velocity winds to low pressure, high velocity winds, providing more coolth as they pass through (see [figure 13](#) and [figure 18](#)).

Strategic placement of dense vegetative cover and wing walls (short walls added to the exterior of a building to direct wind flow) are on-site strategies to channelize the wind. Through the deliberate creation of positive and negative pressure zones, airflow through the building can be increased to provide a cooling effect. This is one of the most powerful cooling strategies available in **hot climates**. Air movement increases evaporative cooling from a person's skin, increasing comfort. This strategy, however, can be challenging in areas with high humidity.

FIGURE 16. Cross-ventilation through shallow plan (Image from Reardon and Clarke, 2013).¹¹⁵

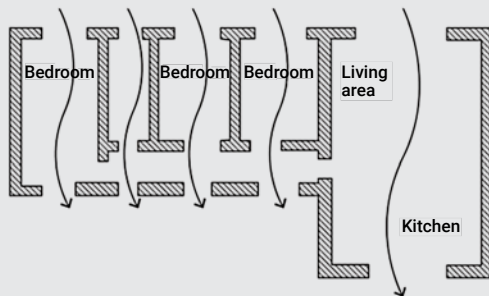
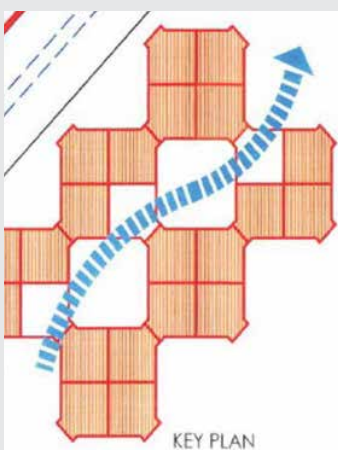

FIGURE 17. The Juanapur slum resettlement, New Delhi (Image from Anangpur Building Centre).¹²⁰



To optimally use the wind flow, a building must be oriented at an angle to the prevailing wind direction; this may create a conflict with solar orientation design. As an example, the prevailing winds in an area, due to the local landscape, may blow from west to east. Orienting the longer wall of a building to capture this prevailing wind contradicts the design suggestions outlined previously (see sections, 4.1, 4.2 and 4.3 in chapter 4). Part of the design process will be weighing the trade-offs and benefits from the various strategies and finding a balance that works best. Building forms with shorter depths can facilitate cross-ventilation throughout the building (see figure 16). Neighbouring building blocks or other features such as trees should be planned to achieve mutual shading to avoid direct solar heat gain, especially during summer.

Fans and open windows are essential to the achievement of summertime comfort in many buildings. Depending on the climate, opening windows may not always be effective on its own to provide relief from overheating. Other measures may be needed, such as cross-ventilation, window shading and strategically orienting the placement of glass walls and windows to reduce heat gain summer. Moreover, the effectiveness of opening windows depends on a resident's preference. Opening windows can be an unacceptable option where insects, dust, smells, lights, noise or fear of unauthorized entry are prevalent.^{113, 121}



4.3.1 Ventilation in hot and humid climate

In **hot and humid climates** the temperature difference between day and night may often be minimal. This means many building types in hot and humid climates use materials with low thermal mass (wood or other materials) that permit for thinner wall construction. Using materials with high thermal mass (including stone, brick) works best when there is time to capture heat and release it during cooler times. A high humidity level slows this process, so using materials with a low thermal mass is often preferable in this climate. Therefore, while thermal mass can contribute to a reduction in cooling energy in hot-dry climates, care should be taken in warm-humid climates, as that same approach is not always as effective.¹¹¹ Large daily temperature ranges are key.

Buildings that take advantage of natural ventilation do provide benefits to the occupants living in a warm and humid climate (see figure 18 and figure 20).

Stilt houses protect from flooding, but they also allow a house to take advantage of higher airflows

FIGURE 18. Design for a house in warm and humid climate (Image from: CPWD, 2013)¹²²

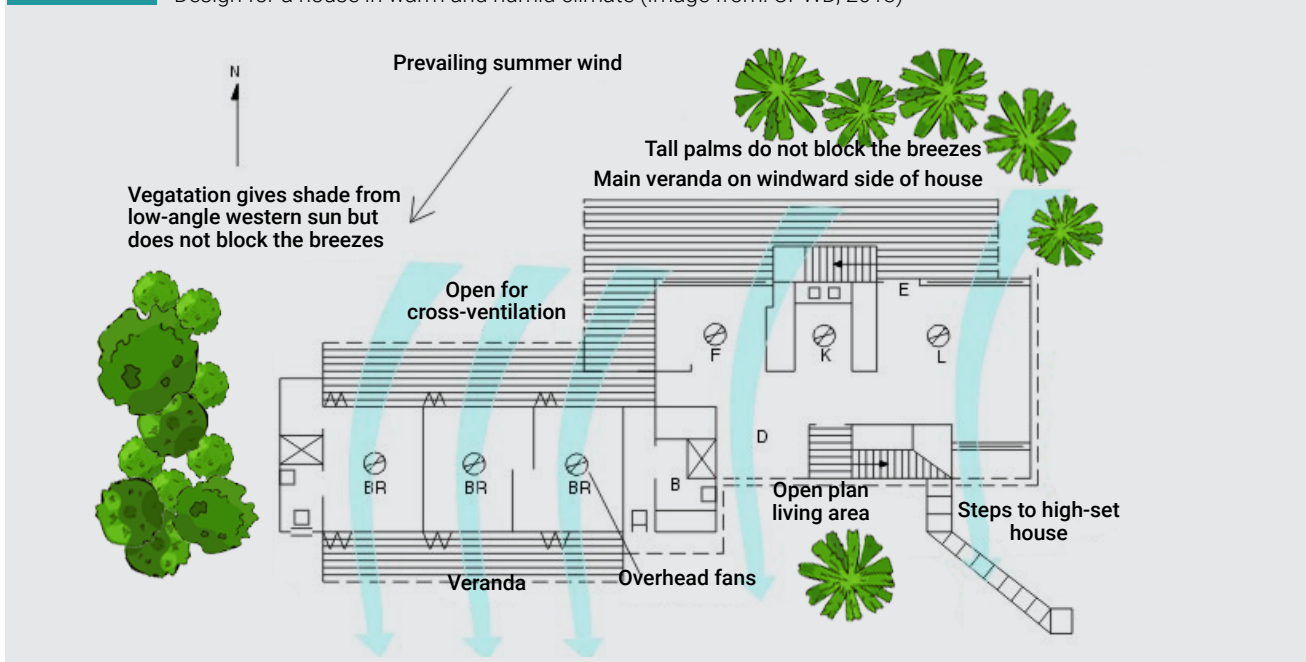

for increased ventilation and comfort (see [figure 19](#)). Wind speed at a height of two meters can be twice as fast as that at one meter, whereas the air near the ground is often stagnant. Therefore, raising a house approximately 1.6 m above ground allows for better thermal comfort indoors and also prevents moisture from entering up from the ground, damaging materials.¹¹⁹

Learning from traditional buildings in hot-humid climate of India:¹²⁴

- Narrow streets / common wall structures to create dense and compact urban form, which increases shading on building exteriors and can help to channelize wind for increased ventilation.

FIGURE 19. Hot and humid climate, maximising higher elevation and vegetation for cooling breezes (Image from McGee, Reardon)¹²³

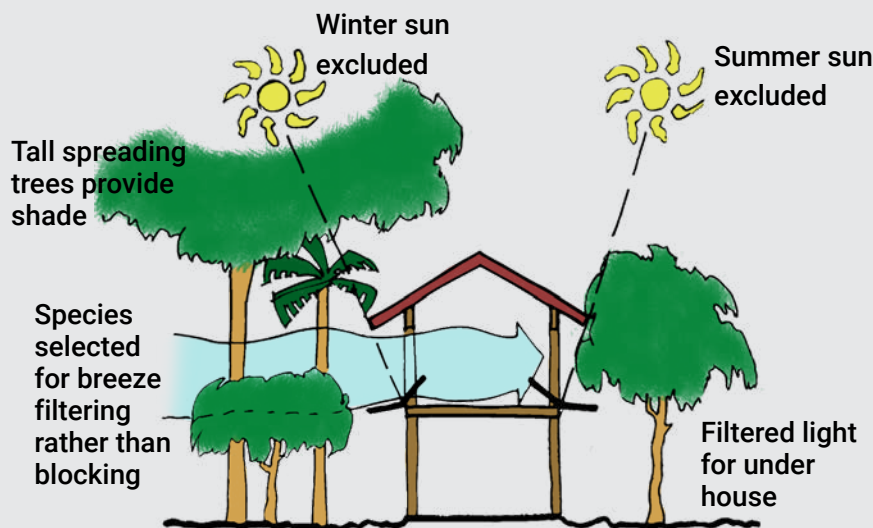
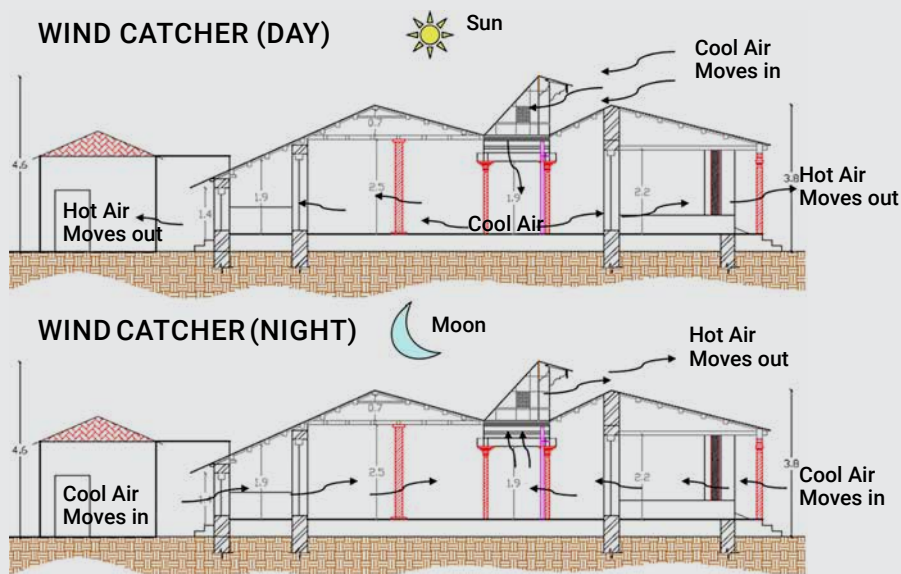

FIGURE 20. Daily energy management in traditional building in Nagapattinam (Image from Priya, Sundararaja, 2012)¹²⁴



- Courtyards in homes for day-to-day activities, which allows occupants to take advantage of breezes or enjoy cooler temperatures in the shade.
- Wind catcher at the top of the courtyard to bring air movement into the house (see [figure 20](#)).
- Walls that are 300 – 600mm thick (depending on material) in traditional buildings provide high levels of thermal mass as a strategy to reduce heat gain. However, with modern techniques and materials (such as insulation), it is better for new construction in hot and humid climates to have a lower thermal mass. This example highlights that planning for climate change can require adjusting traditional building strategies when using modern materials.



4.3.2 Ventilation in hot and dry climate

Ventilation in a hot and dry climate is only useful if the outside air is cool; thus, courtyards should be proportioned to be mostly shaded and contain cooling elements such as trees, soft paving and water bodies (see [figure 21](#)). The courtyard can be cooled through shading by keeping a height to width (H/W) ratio nearing 1:1. Large and long courtyards

also help enhance natural ventilation and reduce humidity. Side corridors can induce wind into the courtyard.¹²²

Courtyards can be planned and sized so they create temperature-pressure differentials that generate cross-ventilation for cooling. Adding small pools, basins or fountains to courtyards enables additional cooling through evaporation. Evaporative cooling works well in the hot-dry climate, as humidity is low in this zone. But for this technique to reliably work and provide benefit, it requires a sustainable availability of water. Two other approaches can be used in arid climates, wind towers and earth air tunnels.

Wind tower system

A central wind tower system with water spray on top is useful for cooling and more effective in designs with rooms on both sides of a hallway (called double-loaded corridors). It is a very acceptable method in hot-dry regions, as the added humidity is welcome because it adds to personal comfort. The introduction of 10m high wet columns may reduce the inside temperature by 12°C for hot arid areas.¹²⁵ For windy areas, new installation of wind towers can be aligned with the predominant wind direction.¹²⁶

- Earth air tunnel system and earthen walls (berming)

FIGURE 21. Different courtyard dimensions for ventilation and mutual shading (Image from CPWD 2013)¹²²

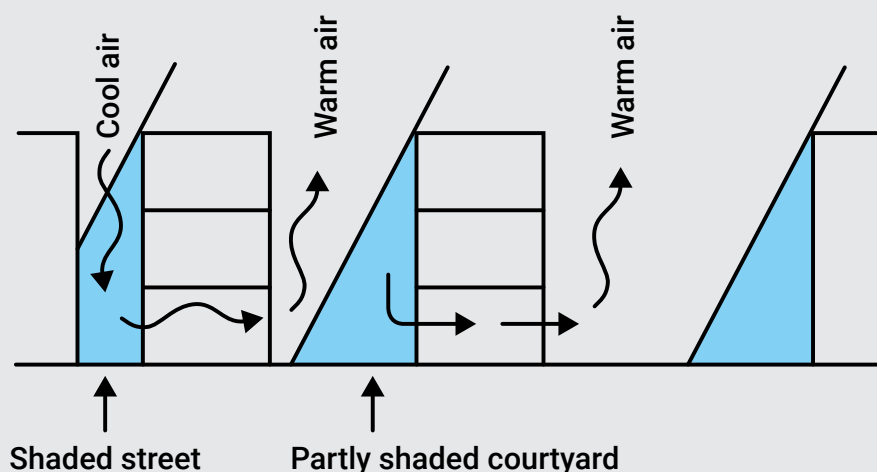

FIGURE 22. Two-story wind tower in Iran (Image from: Dehghani-sanij, 2015)¹²⁶



FIGURE 23. Central wind tower with water for cooling for use in hot and dry climates (Image from Kamal, 2012)¹²⁷

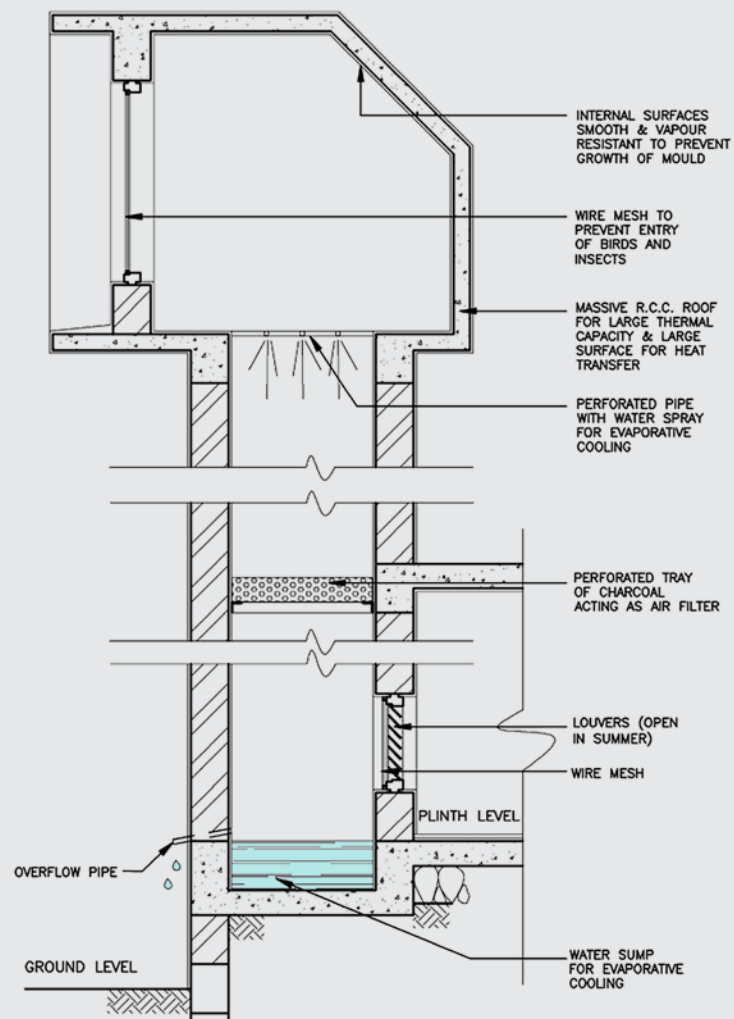
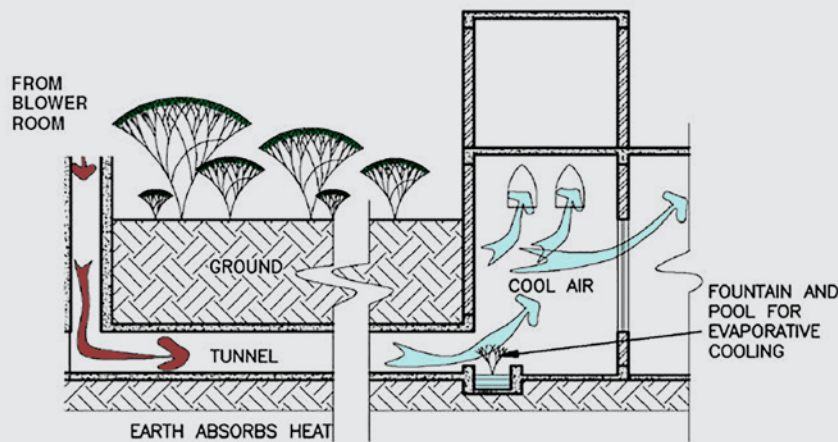

FIGURE 24. Earth air tunnel system utilizing underground temperature to cool (Kamal 2012)¹²⁷

The above examples use night ventilation. These techniques work best when the differences between night-time and daytime temperatures are large. Buildings are ventilated at night, when the ambient temperatures are lower, and the structures can resist heat build-up. Variations of this approach are used throughout the world, a common example of which is opening the windows overnight during a warm summer to allow a home to cool.

These strategies can also ensure minimum heating, ventilation and air conditioning (HVAC) loads if any active cooling systems are desired in the future.

4.4 Shading and cool surfaces



Shading is a long-used approach for reducing the amount of direct sunlight that strikes a building or enters through a window. Adjustable external shading can be preferable in composite or **temperate climates** where heat from the winter sun is desirable; nonetheless, many may opt for fixed shading, as it does not require user operation. A study of public buildings in Burkina Faso found that because of the warming climate, the demand for cooling will increase by 59 per cent by 2050.¹²⁸ Various adaptive building strategies were evaluated, and it was concluded that the installation of exterior shading is

the most energy-effective measure for responding to the impact of increased heat gain in the projected future climate.^{128, 113} In equatorial climates or those that are temperate (e.g. zero cooling degree days, or CDD), fixed shading will likely not be an issue.

4.4.1 Glazing, openings and shading

In addition to nature-based options available for shading buildings, there are design strategies available at the building scale to increase shading and reduce heat gain from exposure to the sun. Most of the strategies outlined below are applicable to any climate. It is critical to ensure all buildings have adequate shading of windows facing west and south (northern hemisphere), which will cut off direct solar radiation during the latter half of the day, especially in hot summer months, but permit winter sun where appropriate. In the southern hemisphere, windows on the northern side of a building may need better shading to block the rising or setting sun. Window shading is commonly achieved with an overhang (see [figure 25](#), label A). The size for the overhang is calculated using the “minimum projection factor for external shading” (a.k.a projection factor). In most cases, it should be 0.5, i.e., the length of overhang divided by the distance from the bottom of the shading element to the bottom of the window glazing (see [figure 25](#)).¹²⁹

In Vietnam, traditional designs (also known as vernacular designs) adapted to increased solar

FIGURE 25.

Projection factor (PF) calculated by dividing overhang (A) by length of window (B). (Diagram modified from Daniel Overbey)¹³⁰

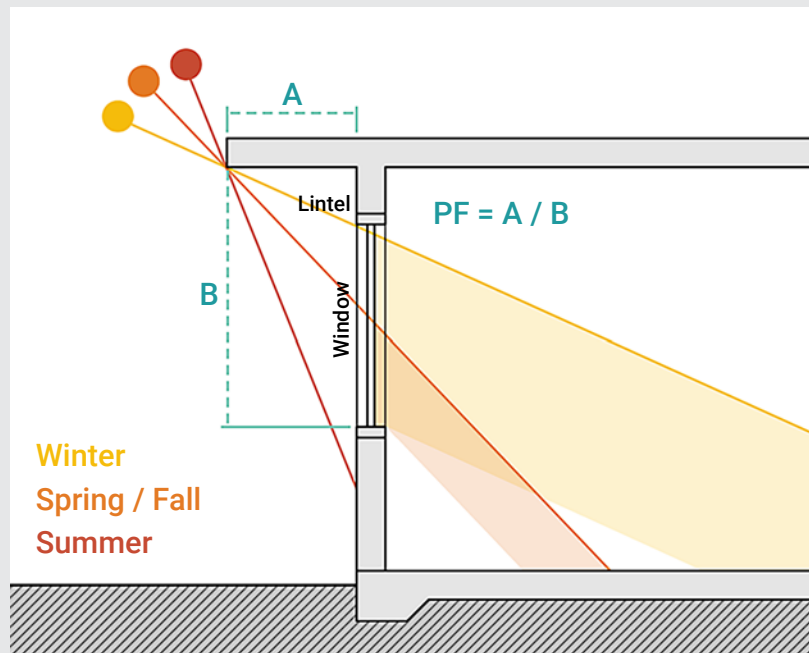

radiation include many large openings facing south including: two windows (1 m × 1.2 m) and three grand doors (1.9 m × 1.9 m) with the intent to enhance natural ventilation. Wooden horizontal slats of wood (louvres) or shutters can shade the glazing, and two-layered windows (French window) provide flexible and operable control of openings during hot and cold periods. An additional front corridor covered by the roof overhang protects the inner space from the sun and heavy rain. In addition, heat absorption by the facades is minimized by painting them white or light colours.¹¹⁹

Shading strategies for building openings are vital for comfort in **hot and arid climate** (see figure 26). To provide adequate daylighting, usually 10 per cent to 15 per cent of a bedroom wall should be windows (known as the window-to-wall ratio, or WWR) and 30 per cent of a living room wall should be windows. The WWR on each façade should be determined based on the duration of sun exposure.

Openable Window to Floor Area ratio (WFR_{op}) for **hot and humid climates** should be a minimum of 10 per cent. WFR_{op} is calculated as a ratio between openable areas to built-up areas of dwelling units.¹³¹

In these climates, the minimum projection factor for external shading should be 0.5 as described in figure 25.¹²⁹

One study in Hyderabad, India, found that occupants were more likely to open windows and doors when the opening was protected from direct solar radiation.¹³²

In the **hot and humid climate**, where cool interior spaces are preferred for most of the year, large glazed windows should be avoided to reduce excessive heat gains and loss from the glazing. A window-wall ratio of 10 per cent to 15 per cent in bedrooms and 30 per cent in living room is optimum to provide adequate daylight. Providing windows at higher lintel levels (tops of windows higher up on the wall) or use of light shelves can increase the daylight penetration into the building (see figure 25). It is also helpful to use fewer windows and less glass on buildings in warm-humid climates. Openings in buildings should be planned on sides that do not directly face the sun, such as the east or west side of a building, to use the diffused light. As a rule of thumb, the distance daylight travels into a room is approximately 2.5 times the height of the top of the

FIGURE 26. Windows and shading strategies for hot and dry climate regions (Image from CPWD 2013).¹²²

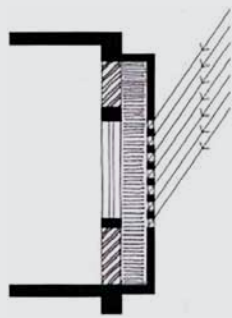

Shading of window and wall surface by jaali screens.

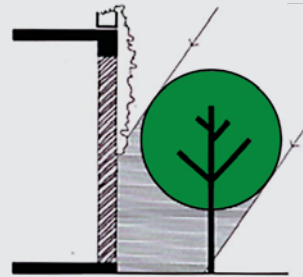

Shading of building surface by vegetation

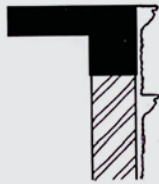

Shading of building surface by surface texture

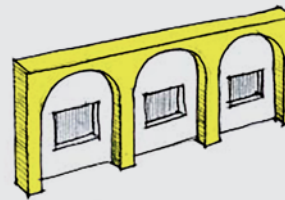

Shading of building surface by architectural projections



Jharokhas are an architectural heritage of the region and provide effective shading. A Jharokha window on the south also cuts out the east-west sun



Besides shading, utilizing Double Glazed Units (DGUs) help insulate the window panel and reduces large heat ingress which would otherwise enter the living space.

© CPWD

window. The shading strategies outlined in [figure 26](#) can also apply to hot and humid climates.



4.4.2 Roofs and cool surfaces

The roof is a large, exposed surface area and can constitute up to 70 per cent of a building's total heat gain.¹³³ This can be a point of vulnerability for a building; as the sun hits the surface for much of the day, a significant amount of heat can enter (in hot climates) or escape the building (in cold climates). As an example, in one study in India, the

apartments, or flats, just under the roof have the greatest use of air coolers or air conditioning during the summer months.¹³² As a result, it is important to protect the roof through appropriate insulation and reflective surfaces. Though air conditioning was not employed, a similar concept (overheating in top level flats) was also observed in the United Kingdom.¹¹⁴

Heat gain from the external walls can be minimized by using light colours on the exterior surfaces (absorptivity < 0.4). Heat gain from the roof can be reduced by using roofing materials with a high solar reflectance index (SRI), including white broken

china mosaic, high SRI paints and other materials. Increasing the reflective quality (albedo) of the roof and walls contributes to an overall reduction in the urban heat island.

In Vietnam, traditional design methods used to adapt to increased solar radiation include:¹¹⁹

- Well-ventilated attics that feature funnel-shaped holes at the side ends (gable) of the roof
- Thick roofs made of plant-based materials (thatch roofs) with a thickness of about 200 mm provide ideal insulation (U-value 0.25–0.35 W/m²K) and absorb moisture, which reduces overheating by evaporative cooling effect.
- Deep eaves, which are the parts of a roof that overhand the sides, shade short walls and protect all walls and openings from direct sun.

Cool roofs reflect sunlight and absorb less heat. They can reduce indoor temperatures by 1°C to 4°C, which has the potential to lower energy bills by up to 20 per cent. Cool roof options may include:¹³⁴

- Cool roof paint (see [figure 27](#)): Cooling potential 2°C to 4°C; reflective paints applied to roofs can help reduce the amount of indoor heat by reflecting heat away from the building.
- Secondary roof (or “fly roof” such as a bamboo shading screen) (see [figure 28](#)): Cooling potential: 3°C to 4°C; a secondary roof is placed on a basic support structure, which provides an air gap between the panel and roof surface. This creates shade and encourages airflow beneath the panel, reducing temperatures.
- Shade fabric (see [figure 29](#)): Cooling potential 2.5°C to 3°C; shading fabric such as a canvas-like material or green matting (widely available as a shade cloth for covering greenhouses) can provide shade of up to 70 per cent. This simple, low-cost application makes it an attractive option to increase thermal comfort by reducing the roof surface temperature. It also makes flat terraces more usable during the hot season.

FIGURE 27. Cool roof paint

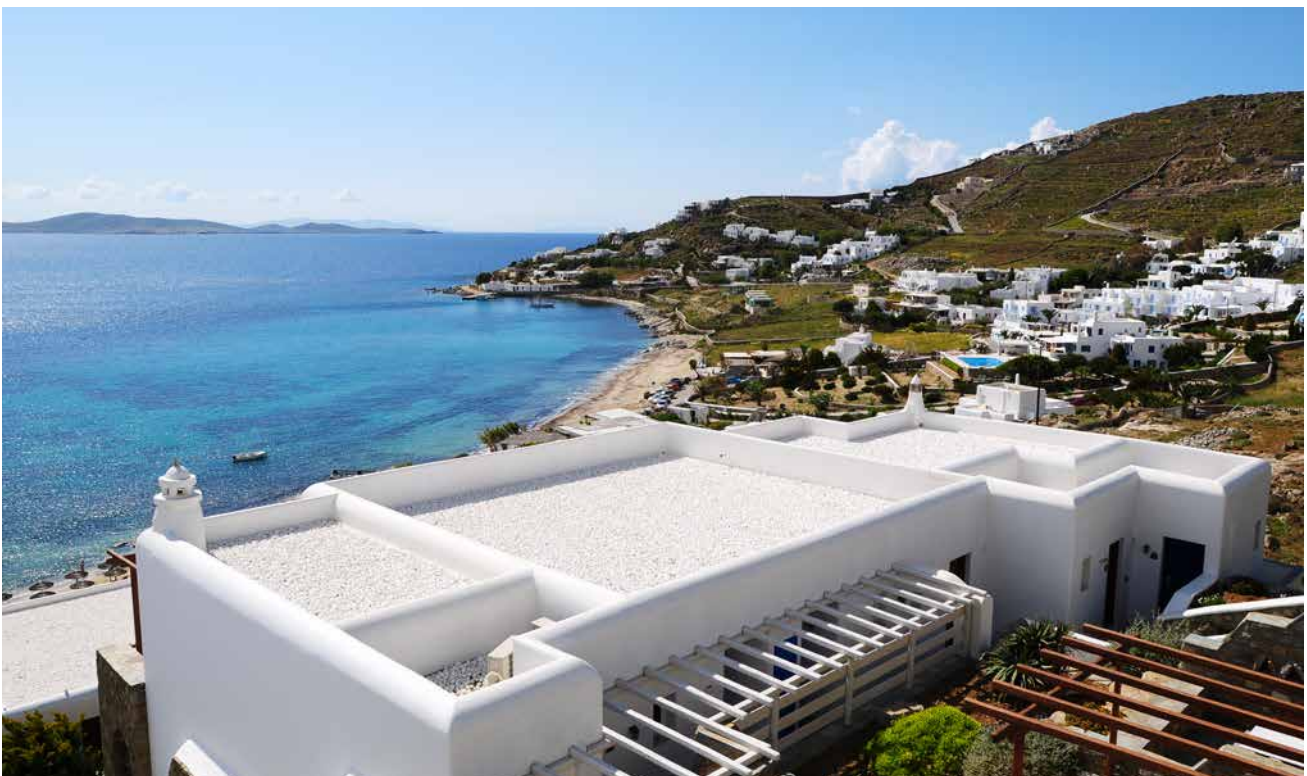

FIGURE 28.

Secondary roof structure, also known as “fly roof.” (Image source: <http://2030palette.org/double-roof/>)
Design by Studio Saxe and Photography by Andres Garcia Lachner



FIGURE 29.

Shade fabric (Design by Jorg Stamm, and built in collaboration with <https://www.giantgrass.com/>)
Photo credit: Giantgrass, copyright permission granted).



- Alternative roof surfacing: Cooling potential 2°C to 3°C. Examples include lime concrete, high reflectivity tiling and Thermocrete. Thermocrete is a kind of concrete mixed with Thermocol (extruded polystyrene) balls. These balls act as air cavities, which prevent some amount of heat from travelling through the material. Both concrete and polystyrene can be environmentally problematic. Fortunately, new alternatives are under development, including products from biodegradable materials such as agricultural waste and fungi. Market availability at present is limited but will likely grow with increased demand. Partial replacement of cement (the energy-intensive material in concrete) with reusable materials would be an effective way to reduce the impact of these materials. Replacements can include fly ash, silica fume and wood ash. Polystyrene is recyclable but not typically recycled; therefore, developing alternatives is strongly recommended.

rooms such as kitchens may be used to heat the other parts of a building, so placing them in a more central part of the building can be beneficial. Lastly, unlike hot climates, streets in cold climates should be wide enough to ensure that buildings on either side do not shade each other. Open spaces between buildings should allow a maximum amount of sunlight to strike a building.¹³⁶

The efficiency of a building to resist heat loss is measured and dictated through building regulations and design standards. Building elements such as walls, floors, roofs and windows are measured by how easily heat or cold is transferred through the material (similar to how tea heats a cup). This is called thermal conductivity (also referred to as U-value in some countries; in other countries the inverse of the measurement is used, i.e. thermal resistance or R-value). Insulation decreases the transfer of heat and cold and provides for a more energy efficient building. Windows are generally the weakest element in the buildings when it comes to thermal resistance.

4.5 Thermal adaptation in cold and temperate climates^{§§}



4.5.1 Cold climates

In cold climates where heat gain is desirable at times, buildings should be located on the south slope (in the northern hemisphere) of a hill or mountain for better access to solar radiation. The exposure to cold winds can be minimized by locating the building on the leeward side. Many of the building orientation and layout strategies mentioned earlier apply here as well. However, there are two key differences worth highlighting here. Ventilation should be carefully planned and air-lock lobbies at the entrance and exit points of a building should be used to reduce heat loss. Additionally, heat generated by appliances in

In a cold climate, insulation should have a vapour barrier that is sufficient to prevent moisture on the warm side from passing through and causing condensation. Suitable insulation materials include two coats of bitumen, 300 to 600-gauge polyethylene sheets and aluminium foil. In some places with very hot summers (as indicated by a high number of cooling degree days (CDD)^{***} where insulation may lead to overheating in the summer, external insulation is preferable to internal or cavity wall insulation.¹³⁷ This is because the insulation layer is the first and best defence at resisting the heat gain from the environment.

For buildings in cold-dominated areas (as indicated by the number of heating degree days (HDD)), the external surfaces of the walls should be dark in colour so that they absorb heat from the sun during the day. A sufficiently sloping roof enables quick drainage of rainwater and snow. Windows or glass

^{§§} Advice that applies in a cold climate can be applicable in temperate and composite climates depending on their heating seasons (number of heating degree days or HDD).

^{***} Reminder: Heating degree days (HDD) and cooling degree days (CDD) are a way to measure how hot or cool it has been over a 24-hour period. HDD is any day that has a mean temperature below a base outside temperature (usually between 15°C and 18°C). CDD is any day with a mean outside base temperature above 18°C to 22°C (base temperatures are usually determined by policy).

(known as a skylight) on the roofs admit heat as well as light in winters. Skylights can be provided with shutters or shades to avoid overheating in summers.

Double-glazing (two layers of glass in a window) with low-E glass or double clear glass performs better than a single layer (pane) glass. They should be sealed effectively to avoid heat loss during winter nights. Condensation in the air space between the panes should be prevented. Openable Window to Floor Area ratio (WFRop) for cold climates should be a minimum of 8.33 per cent. WFRop is calculated as a ratio between openable areas to built-up areas of dwelling units.¹³⁸ The Window to Wall Ratio (WWR) on each façade should be determined based on the duration of sun exposure. Visible light transmittance (VLT) of the windows or other glass, transparent, or translucent features should comply with the requirements given below, which allow for better control of the internal temperature of a building.¹³⁸ If windows amount to 20 per cent or less of a wall then the windows should allow 75 per cent of visible light into the building. If windows account for 35 per cent of a wall, then they should only permit 40 per cent or less of the visible light into a building. Combining this strategy with good wall insulation and building orientation can keep a building comfortable even with a changing climate.

Window-to-wall ratio	Minimum VLT
WWR <20%	≥75%
WWR 20% to 30%	≥50%
WWR 30% to 35%	≥40%

Windows should be placed to facilitate direct heat gain, which is a passive heating technique that is generally used in cold climates. It was a common feature of traditional building in many cultures, from ancient China to settlements in the Middle East and pre-Columbian north America. In this technique, sunlight is admitted into the living spaces directly through openings or glazed windows (see [figure 30](#)). The sunlight heats the walls and floors, which then store the heat using their thermal mass and transmit the heat to the indoor environment, usually at night.

The main requirements of a direct gain system are large glazed windows to receive maximum solar radiation and thermal mass for storage, which help reduce the speed of heat loss. This is illustrated in [figure 30](#), which shows the thermal mass of walls, floors and part of the roof. Carpets and curtains should not be used to cover the floors and walls used as storage mass because they impede the heat flow rate. Suitable overhangs for shading and openable windows for ventilation must be provided to avoid overheating in the summer.

A Trombe wall is a passive solar design element that is simply a heavy mass (concrete, stone and similar materials), equator-facing wall that is sometimes painted a dark colour in order to absorb thermal energy from direct sunlight. The heavy mass of the wall soaks up the heat from the sun and radiates it out when the temperature is cooler. Trombe walls have been used in countries such as Chile,¹³⁹ China¹⁴⁰ and Egypt.¹⁴¹

Water walls are based on the same principle as that of the Trombe wall, except that they employ water as the thermal storage material. The water wall is made up of drums of water stacked up behind glazing. It is painted black externally to increase the absorption of solar radiation. This set-up can store more heat than concrete walls due to the higher specific heat of water.¹³⁶

The Trombe wall concept can also be applied to the floor of a sunroom or solarium (see [figure 31](#)). A room as a solar air collector can be incorporated on the south-facing space. The glazed roof can collect direct solar gain, and hot air collected in the room can be used for space heating purposes.

In winter months in cold regions, the windows and other openings are generally kept shut; ventilation necessary for the control of odours, indoor air pollutants and the products of combustion can be achieved either by stack effect or by some infiltration of outside air due to wind action.¹²⁹ The solar chimney can provide this stack effect (see [figure 32](#)).

The system can be integrated with the roof or a wall and is a modification over a Trombe wall. A solar chimney, on an external wall, enhances stack ventilation by providing additional height

FIGURE 30. Direct solar gain system. (Image from Nayak and Prajapati, 2006)¹³⁶

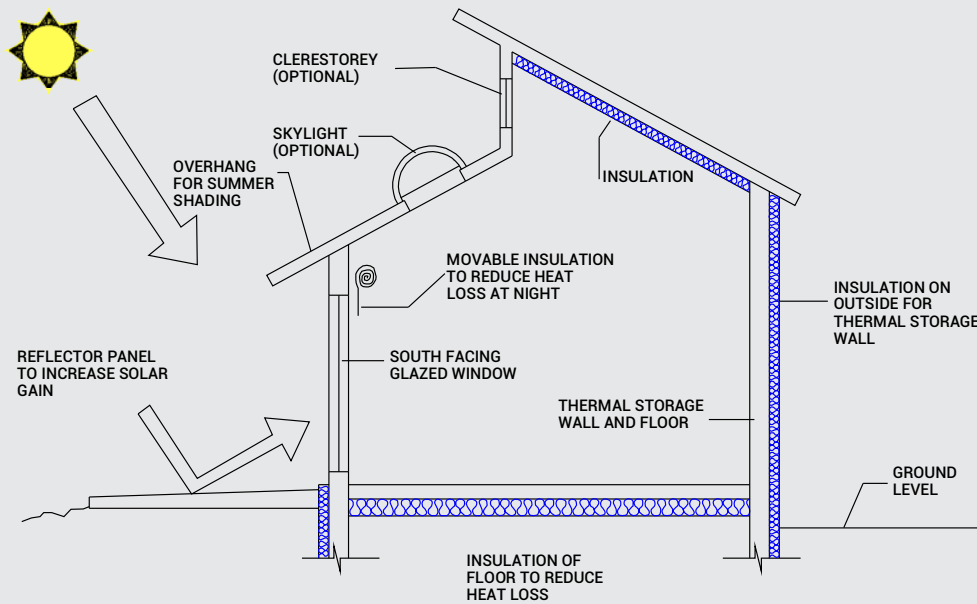
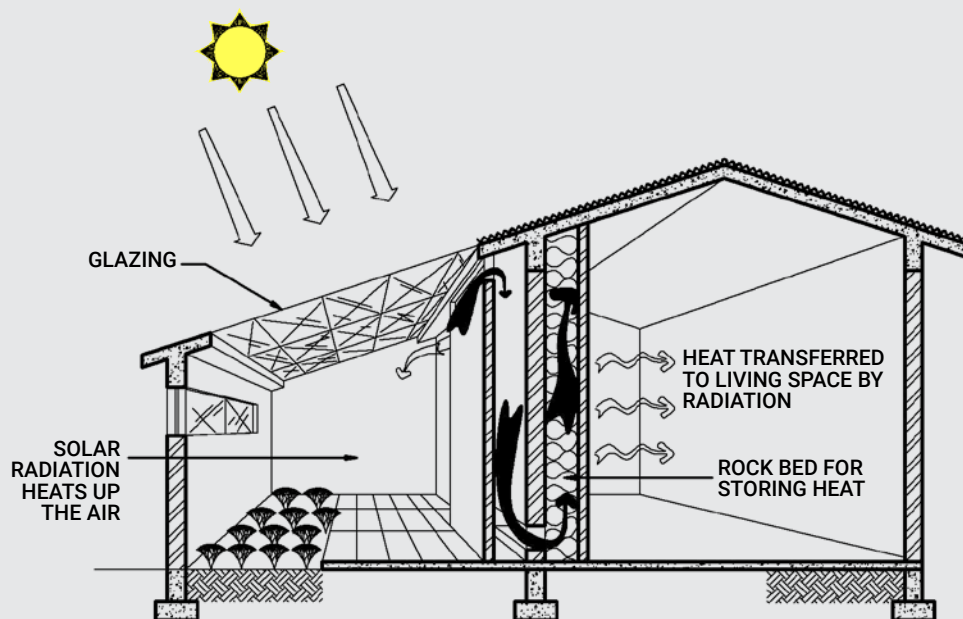

FIGURE 31. Solarium with Trombe wall as used in High Mountain regions (Diagram from Nayak and Prajapati, 2006)¹³⁶



and well-designed air passages thereby increasing the air pressure differential. Via solar radiation, the chimneys warm the rising air and that increases the temperature difference between the incoming and outflowing air.

These measures increase the natural convection and enhance the draw of air through the building. In addition to cold regions, this approach has been applied in Malaysia, Singapore and the Middle East.^{142, 143}

FIGURE 32.

Solar chimney wall (Image from Reardon and Clarke, 2013)¹¹⁵

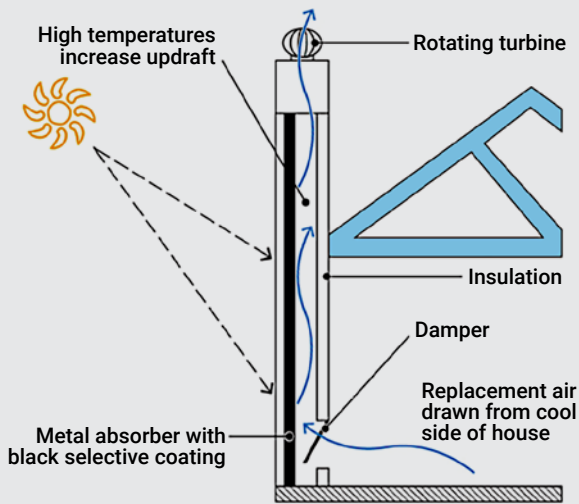

4.5.2 Thermal adaptation in composite and temperate climates

The same rules apply to these climates as to those that apply to cold and hot climates as outlined above. Many composite and temperate climates need to apply a mix of adaptive responses that are applicable to both hot and cold climates. Many of the same ventilation and shading recommendations apply but depend on the amount of seasonal shade needed and the ability to ventilate, given the particular climate. In contrast to the most extreme hot climate, where fixed shading is beneficial all year, shading that can be adjusted (operable shading) is best in these mixed climates where seasonal control of solar gain is beneficial. Specific climate classifications (such as degree days) dictate the required insulation levels, and local building codes or green building schemes likely include recommendations. Where these recommendations do not exist, studying building codes and especially green building programme documentation from similar climates can provide insight.

4.6 Materials for thermal comfort



When choosing products and building design, it is important to consider thermal performance. Thermal performance, or how well a building responds to changes in outside temperatures, is most impacted by the type material selected. Therefore, when choosing materials, it is useful to consider the product's "thermal transmittance" (also known as the U-value). The lower the U-value of a material, the better it is at keeping the indoor temperature comfortable even when there are large temperature changes outside. [Section 5.4](#) in chapter 5 has more information on the U-values of common materials and design approaches.

In addition to thermal performance, changes can be made to the exterior surfaces, also known as the skin or fabric of a building. These changes can be extensive but also highly beneficial in adapting to change. Choosing a material with either a high or low reflectivity (albedo) for a building's exterior surfaces can be useful depending on the climate. In a hot climate (cooling-dominated), using high reflectivity (albedo) surface coatings or materials works best. It can work as well in composite or temperate climates; however, it will reduce the useful heat gain in the winter.¹¹³ Where a balance needs to be achieved, careful consideration of the present energy needs throughout the year with future climate change is important. In the same way, insulation is essential in both hot and cold climates; but the position of that insulation can cause problems in different seasons.¹³⁷

One key area where heat transmission should be minimized is through the building's walls and windows (referred to as the building envelope). Increasing thermal mass, adding insulation in the wall and adopting similar strategies will help in minimizing this heat transfer.

Analysis and recommendations exist for nearly every climate region. These recommendations typically provide a range of optimal U-values (an indicator of thermal performance) for walls, roofs and windows.

For example, the baseline U-value for different building components, as defined in the Indian Green Building Council's Green Affordable Housing Standard, are listed below.¹⁴⁴ A value lower than baseline means the component is more energy efficient. For example, if a wall has a U-value of 2.0, it is more energy efficient than a wall with the baseline value of 2.5.

Building component	U-value (W/m ² K)
Wall	≤2.5
Roof	≤1.2
Glazing	≤5.7

Building component	U-value (W/m ² K)
Glazing (SHGC)	
WWR <20%	0.25
WWR >20%	0.2

The recommended values in many countries can vary depending on local climate conditions. For example, the maximum allowed U-value^{†††} in South Africa range from 0.45 to 0.53 for walls and 0.27 to 0.37 for roofs, depending on the local climate zone.¹⁴⁵ In Brazil, which has both hot-humid and hot-dry climate zones, it ranges from 2.2 to 3.6 for walls and 2.0 to 2.3 for the roofs.¹⁴⁶ Knowing the local climate and recommendations for U-value allows for the selection of the most appropriate material.

For both energy and cost efficiency, it is also important to match the amount of insulation and the optimal thermal mass of the materials. In general, use of insulation with low thermal mass materials will not be effective in keeping indoor temperatures comfortable. High mass construction with insulation is the most effective strategy in hot climates to reduce heat gains and should be used with proper shading. In the hot-dry climate, insulation should be on the external side with the high mass material on the inside, protecting it from the summer sun.

^{†††} Please note: Some countries utilize U-value (how easily a material transmits heat) to measure thermal performance, others utilize R-value (a material's resistance to heat transfer). They both measure thermal performance, and many building materials now provide both values for help in making the best choice.

Use of natural ventilation for improved thermal conditions

A case study in India examined the thermal comfort in 30 different residential and office buildings located in varying climatic regions. It showed that achieving thermal indoor comfort with natural ventilation is feasible. However, with higher outdoor temperatures a need to supplement airflow through the occasional use of additional means, such as fans, was needed to relieve discomfort.

More studies in different climatic locations are needed, but the use of natural ventilation presents promise on a global level for improving indoor thermal comfort. Although natural ventilation does not require advanced technical components, it does require informed building design.⁵

5 Adaptation ideas for specific climate risks: flooding, droughts and cyclones



Ho Chi Minh City, Viet Nam - October 18, 2016: Awful flooded street at Asian city.
© shutterstock.com

This chapter highlights design concepts and approaches that can be used to mitigate risk from climate disasters. Real world examples are included to help illustrate the concepts and provide a starting place for conversations with design professionals prior to implementation. The examples in the following sections are grouped by risk and [table 7](#) in the conclusion provides a summary table of the approaches.

5.1 Changing rainfall patterns and droughts



There are two key approaches to address increased rainfall at the building-scale; the first is rainwater harvesting, and the second is increasing the area for rainwater to seep into the ground. Rainwater harvesting reduces run-off in urban areas and also permits water storage and use in buildings.¹⁴⁷ If a storage tank is large enough, challenges from periods of drought can be met with the collected rainwater. Water conservation and reuse is of utmost priority in the **hot and arid climate**. For buildings that have irrigated gardens or other landscaping features, water conservation can be done through more efficient landscaping and supplementing or replacing water use with rainwater harvesting.

- If the harvested rainwater (see [figure 33](#) and [figure 34](#)), is not needed for use in the building, it can slowly be released to recharge groundwater. This approach will avoid runoff and reduce flood risk, as rainfall in hot-dry areas is low and infrequent and the existing water table is typically low. Rainwater harvesting potential is calculated as catchment area (m²) x annual rainfall (mm) x surface run-off co-efficient (different surfaces absorb water at different rates). Rainwater harvesting tank size calculators can be found online.
- Water efficient landscaping includes the use of native, low water-consuming species in site landscaping, reducing the use of exotic species and grass lawns, with an efficient irrigation system to reduce water consumption. This **nature-based solution** enables a longer use of captured rainwater.

In other climates that receive heavy rainfall, like **hot and humid climate**, capturing and preserving rainwater is also an excellent way to reduce potable water consumption and address the water crisis.

The second approach for addressing increased rainfall is providing space for rainwater to permeate the ground, also known as ground-water recharge. This helps to restore the more natural water flows that existed before paving or hard surfaces were installed.

Nature can provide pervious or semi-pervious surfaces on site, in the form of trees, vegetation, grass pavers, pebble beds, swales and berms, that also help to reduce run-off and allow for ground-water recharge through a larger area (see [figure 35](#) and [figure 36](#)).

FIGURE 33. Rainwater harvesting and recharge system as used in India (Image from CPWD 2013)¹²²

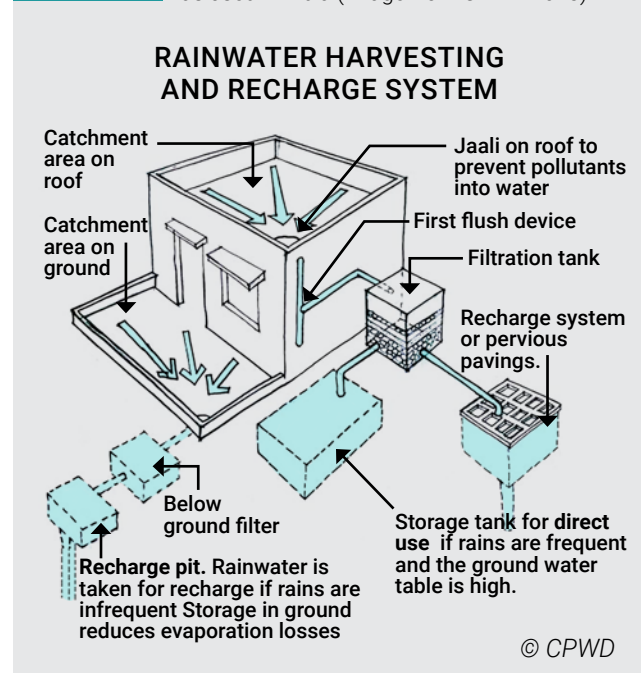

FIGURE 34. Rainwater harvesting tank, Uganda (Image from: Baguma et al., 2012)¹⁴⁸



FIGURE 35. Lattice unit grids for storm run-off control, pedestrian pathways and soil conservation (Image from: TERI, 2004).¹⁴⁹

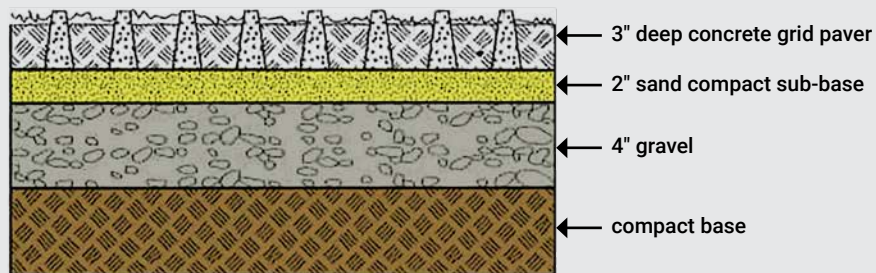
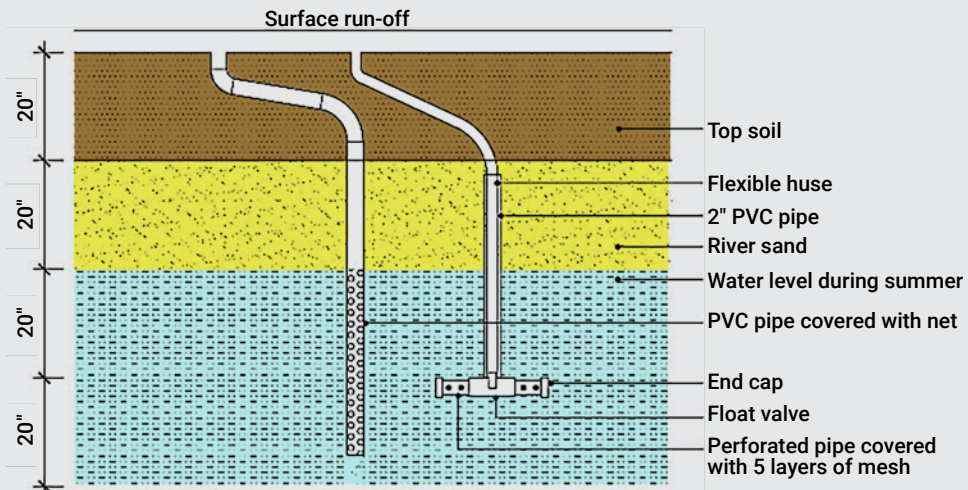

FIGURE 36. Rainwater harvesting combined with a pavement design at an interval dependent on the run-off (Image from: TERI, 2004)¹⁴⁹



The type and amount of rainwater harvesting suitable for a building development varies and depends on the climatic zone, rainfall intensity, soil conditions, run-off volume and site design. National building codes, local building bylaws and legal requirements should all be checked when planning, sizing and detailing rainwater harvesting systems in a development.

5.2 Adapting to stronger storms and flooding



Building design and construction can address flooding in several ways, foremost among them is avoiding flood-prone areas. When that is not possible, then raising houses or buildings above the flood level is key. This can be accomplished by permanently raising the building with a higher foundation or first floor. Or, in some cases, buildings can be designed to float upon the water. When even these options are unavailable, it is important to consider the type of materials used as well as how the house is laid out or configured, for example, by having the bedrooms on the top floor with the kitchen and communal spaces below. Beyond the building itself, there are options for improving the

local area through nature-based solutions such as better drainage, stabilizing riverbanks and using paving materials that allow rainwater to pass through, which reduces the amount of storm-water run-off from a rain event. Lastly, early-warning systems and evacuation plans ensure greater safety for residents.

One example of using different materials comes from Nigeria, West Africa. After the catastrophic floods there in 2012, most of the houses made with mud walls were destroyed. Residents in the most affected areas were offered the option to relocate, but a significant number of households chose to rebuild on the same site. Given that most houses built with concrete walls had survived the flood, almost all houses were rebuilt using concrete, resulting in a lower probability of collapse and fewer expected human casualties in case of a similar flood.¹⁵⁰

Figure 37 shows a flood-resistant house in Kerala, India. Pillars have been constructed with treated bamboo, mud and concrete. Plastering has been done with mud tiles, coconut shells and treated bamboo. The house can sustain itself as well as any other concrete structure. In case of a flood, the inhabitants can await evacuation on the third storey.¹⁵¹

FIGURE 37. Flood resistant home in Kerala, India (Image from Rajendran 2019)¹⁵¹



In Malaysia, one solution to coastal flooding involves “water buildings” (see [figure 38](#)). Water buildings are elevated an estimated 2.5 meters from the ground to allow water to flow and the wetland vegetation to grow underneath. The passage connects each house to the village pathway as a transition space between public and private domains. A front porch covers the main entrance of the building and provides space for parking bicycles and/or scooters. In some cases, the front porches of some of the water buildings in the villages were converted

to coffee shops, grocers or family craftwork stalls. A back porch provides a secondary, more private entrance and fire evacuation route. A workshop is connected to the core house by a passage and built at a strategic location for water access. This provides storage and is where the household carries out fish processing.¹⁵²

In Nigeria, adaptation measures include planting trees for soil stabilization, renovating with flood-resistant materials, elevating buildings and installing

FIGURE 38. Malaysian water building design (Image from: Lai and Cheng, 2019)¹⁵²

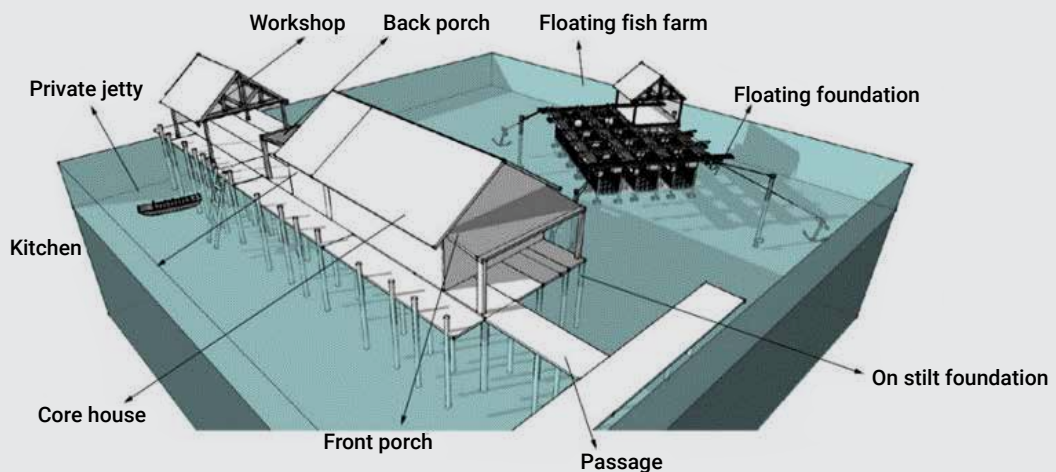
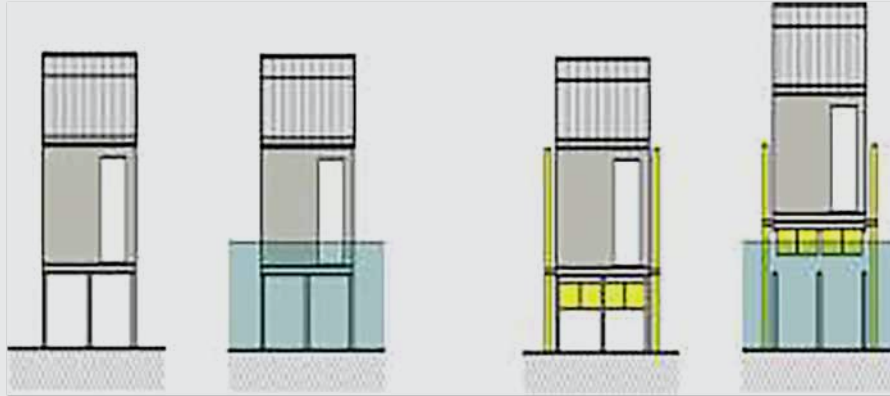

FIGURE 39. Shelter of kindness – Proposed multipurpose hall in Bangladesh which also functions as a raised emergency shelter. The building would rest on pillars and has buoyant tanks that raise it up during floods. (Image: GiantGrass, 2011, permission granted - <https://www.giantgrass.com/project/shelter-of-kindness-2/>)



FIGURE 40.

Dwellings on stationary plinths (left, dwelling gets flooded) vs. the amphibious dwelling (right, dwelling floats when flooding occurs) (Image from: Khanolkar, Jadhav, and Patekhede, 2019)¹⁵⁷



permeable paving and flood gates.¹⁵³ Elevated dwellings in India were evaluated using a cost-benefit analysis for the initial investment for the structural columns (plinths) for raising permanent, semi-permanent and non-permanent construction in India. The study found that when compared to standard construction, the benefits of an elevated building far exceed the costs of construction.¹⁵⁴ However, implementing this change often requires additional policy interventions related to capacity building and finance.¹⁵⁵

Taking the raised dwelling concept a step further, [figure 39](#) shows a proposed design for community building in Bangladesh. Designed to provide emergency shelter during cyclones this building is also capable of raising up in case of floods. Buoyant tanks under the building can lift it up higher if flood waters rise. This approach is also seen in amphibious homes which, under normal circumstances, rest on a concrete foundation and start floating when the water level rises during flooding (see [figure 40](#)). [Figure 41](#) shows one solution used in in a house in New Orleans for the floodwater-prone region. The house in the flood-prone Lower Ninth Ward of New Orleans is built on a prefabricated chassis made of polystyrene foam coated in glass fiber-reinforced concrete that is lightweight enough to serve as a raft when floodwaters buoy the home up.¹⁵⁶ The advantage of these homes is that they are like ordinary homes in the area, with a parking space, a garden and access from road. The houses are kept in place by the support of two mooring poles. These

steel columns are driven deep into the ground. Even during extreme flood conditions, the steel columns will keep the structure in place and able to withstand a fast-flowing water current. A steel framework connects these steel columns. The house will only float during floods, which is the one situation (or weather event) in which its inhabitants will feel the structure moving and behaving differently than a typical house.¹⁵⁷

FIGURE 41.

Amphibious house in New Orleans, USA (Image source: Wang, 2017)¹⁵⁶



Floating buildings as an adaptation to flooding

Three different architectural adaptation measures to flooding.⁴

1. **Amphibious housing:** In case of increased water levels, the building structure together with the supporting pedestal can separate from the mainland and float.
2. **BACA floating house:** A foundation designed like a honeycomb out of reinforced concrete with air pockets allows the house to float up to almost three meters in case of flood. The solution is especially appropriate for areas where floods are frequent, such as in proximity to rivers.
3. **Amphibious container:** A container home that can hover by using pallets and tires. The house can withstand rising water levels up to 2.5 meters. The container is always designed to fit the local environment and can be built using repurposed material, such as old shipping containers, inner tubes from tracks and scrap pallets.

These are all highly technical solutions, requiring significant resources and specialized skills.

5.2.1 Wet-Dry architecture

areas is not feasible, for example, in urban areas experiencing more frequent flooding due to climate change. In addition to the approaches outlined above, a building or home can also be designed and constructed so it is more capable of recovering after flooding or moisture intrusion. Techniques such as keeping electrical, heating and ventilation systems above flood lines or building walls to reduce wicking of moisture up into walls and insulation or other absorptive materials aids in prolonging the material life but can also reduce risks associated with mould and fungal growth.

Property loss and damage from flooding can be further reduced through the careful selection of building materials - favouring those materials that withstand moisture damage - as well as by planning the layout and occupant use of a building. Example materials are outlined later in the materials section (see [table 6](#)).

[Figure 42](#) shows a qualitative assessment of the occurrence of structural and non-structural adaptation measures to flooding at various scales in Kibera, Kenya. Examples of some of the presented adaptation measures are shown (see [figure 43](#)).

FIGURE 42.

Qualitative assessment of the occurrence of structural and non-structural adaptation measures to flooding at various scales in Kibera, Kenya. (Figure from Mulligan, Harper 2016.)¹⁵⁸ Structural measures refer to efforts directly related to building design, whilst non-structural measures include a wider range of efforts, predominantly related to maintenance and governance. The columns show the scale of implementation, and the rows present different adaptation measures. The extent to which the different measures occurred is depicted using circles, explained in the top diagram

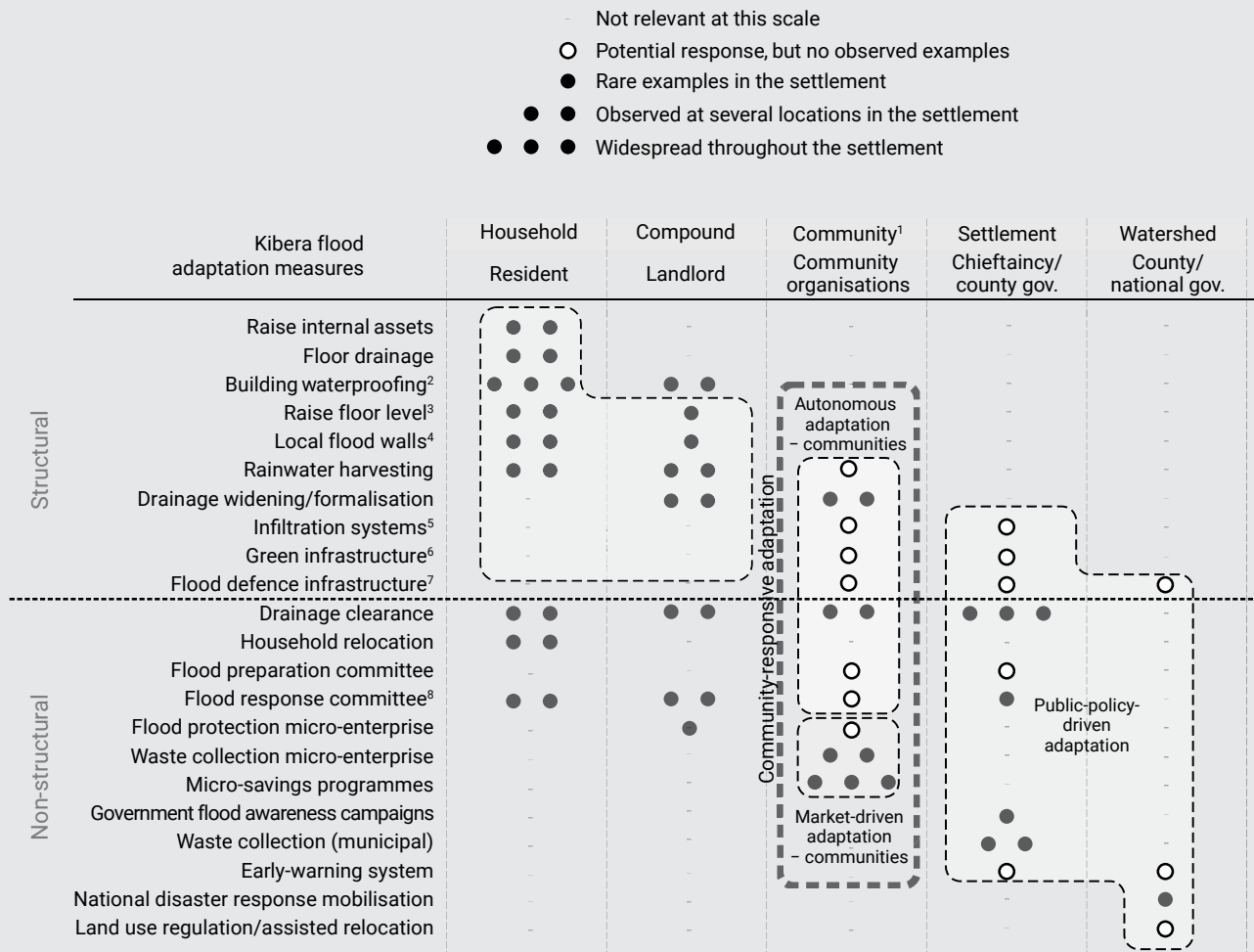

1. For the purposes of this paper 'community' describes a group of people living or working in a graphically defined area where maintenance, for example of drains, could be carried out by community groups. In Kibera these areas tend to be less than 1 ha. These geographical limits may, or may not, coincide with other ethnic, religious, political, administrative or socioeconomic boundaries.
2. Measures to prevent ingress of water into structure and reduce damage to structure and internal assets – for example raised doorstep, sandbagging of water entry points, external wall plastering, roof improvements.
3. Elevation of habitable space above the river flood level – for example raising ground floor level, building a second storey.
4. Non-engineered walls built by residents to contain water from major drainage channels and rivers.
5. Systems that are used to capture surface water runoff and then allow it to soak into the ground – for example soakaways, permeable pavement, filter darins, rain gardens.
6. Building with nature to provide water quality, amenity and attenuation benefits – for example planted swales, landscaped erosion protection protection, ponds.
7. Engineered infrastructure that reduces the risk of flooding for a particular area to a (considered) acceptable level – for example embankments, dams, flood walls, barriers.
8. Organisations and residents that undertake flood emergency recovery activities whether they be formal (e.g. civil society) or informal (e.g. temporary housing by family members).

Examples of autonomous adaptation measures at household and community scales in Kibera: (a) doorstep for stopping water ingress; (b) local flood wall and raised building foundation; (c) double-storey building for raising assets and living area; (d) local gabion wall embankment wall. (All photographs by Pascal Kipkemboi and Anna Collins.)¹⁵⁸

FIGURE 43.



(a)



(b)



(c)



(d)

5.3 Cyclones and wind-storms



5.3.1 Roofs

The key feature for a building's resistance to cyclones is the roof. Wind researchers at the Centre for Building Science and Technology (CSTB) in France developed a prototype of a "cyclonic" or hurricane-resistant dwelling.¹⁵⁹ The best performing structure was a square, elevated building atop an open foundation. The home had a hip roof (see [figure 44](#)) and was equipped with a central shaft with aerodynamic features designed to reduce wind forces during an extreme wind event (see [figure 46](#)). Other research and studies have also found this to be one of the safest ways of constructing homes and buildings for areas prone to high winds. Summarized here, the following construction considerations for homeowners in cyclone-prone regions are recommended.¹⁵⁹

- Home shape: A home with a square floor plan (or better, a hexagonal or octagonal plan) with a multiple-panel roof (four or more panels) was found to be less vulnerable to wind by reducing wind loads (wind load is the pull, push or shear force on a building from the wind).
- Roof slope: Roofs with multiple slopes such as a hip roof (four slopes, as seen on the left in [figure 44](#)) perform better under wind forces than gable roofs (two slopes, on the right in the figure below). Gable roofs are generally more common because they are cheaper to build. Studies show that a 30-degree roof slope has the best results in resisting strong winds.
- Roof-wall connections: Wind forces on a roof tend to be uplift forces, pulling up on the material. This explains why roofs are often blown off during an extreme wind event instead of pressed down into a home or building. Strong connection of roofs to walls is important.
- Structure-foundation connections and wall-to-wall connections: Strong connections between a structure and its foundation and connections between walls are also important. Structural failure is often progressive, where the failure of one structural element triggers the failure of another, leading to a total collapse.
- Aerodynamic features: Certain areas of a building such as the ridge of a roof, corners and eaves are normally subject to higher wind pressures. In the cyclonic home design, CSTB researchers proposed some aerodynamic features to alleviate these local pressures,

FIGURE 44. Hip roof which performs well under wind forces (Gable roof for comparison on the right).

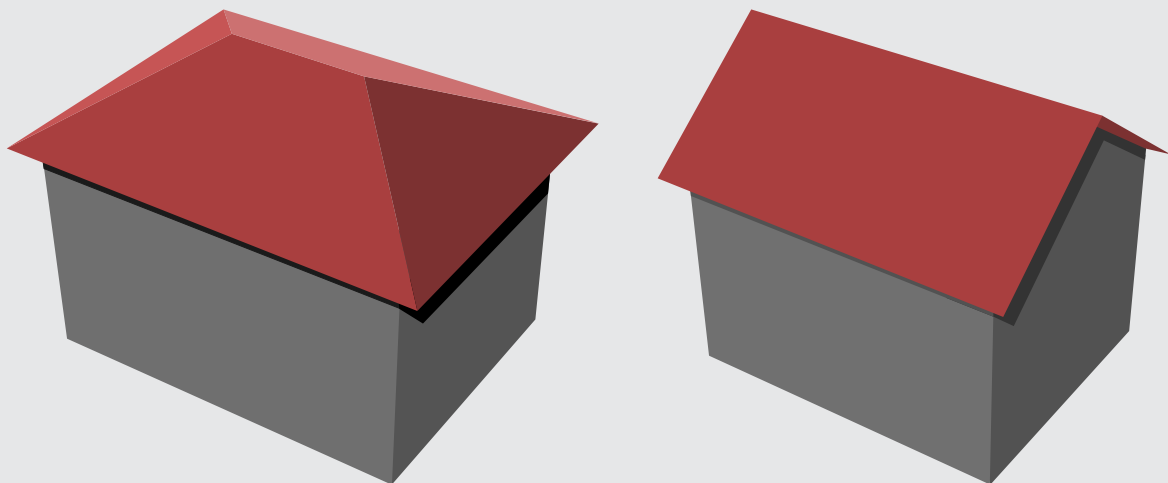



such as introducing a central shaft that would function by creating a connection between the internal space and the roof ridge (the area where two sloped roof sections meet) considered to be the location of the largest depression. This connection helps balance wind forces on the roof, which lessens the wind load (see [figure 46](#)).

- Roof overhangs, verandas and patio roofs: Roof overhangs are subject to wind uplift forces that could trigger a roof failure. In the design of the hurricane-resistant home, the length of these overhangs should be limited to 50 cm. Build veranda and patio roofs as separate structures rather than extensions of the main building as they may damage the rest of the house if separated (see [figure 45](#)).
- Simple systems: The design of the cyclonic home includes simple systems to reduce the wind stresses at the roof's lower edges such as small openings along the perimeter of the home to be installed at the level of the gutters to allow wind to flow through.
- Structure and foundation design: An elevated structure on an open foundation (one that is raised above the ground on blocks, columns, or stilts) reduces the risk of damage from flooding and storm-driven water.

adequate slope (not lower than 12.5-degree roof slope) to withstand strong winds. Furthermore, roofing sheets should be nailed to the roof support and tied with galvanized wire (see [figure 47](#)). The roofing cover sheet must be sufficiently waterproof, constructed with water collection system (gutters and drop tubes) made of suitable PVC and/or aluminium materials, and of a strength that is resistant to winds and can support a rain harvesting system.¹⁶⁰

Roof materials and type can impact its ability to resist damage from storms, including high winds and hail. Steel roofs offer better protection in hailstorms than concrete, slate and terracotta tiles, according to new research by Australian National Roads and Motorists' Association (NRMA) Insurance. Preliminary research has found that corrugated steel performs best overall, holding up against hailstones up to 10 cm in diameter. While the steel sheets can be dented by smaller hailstones, they are not penetrated as easily as tiles, so they are less likely to allow water into the house. Concrete and new terracotta tiles also performed well, surviving the smaller hailstones and only cracking from 7 cm stones. The worst performing were the old terracotta and old slate tiles, where 5 cm hailstones caused the tiles to crack.¹⁶²

In Mozambique, a secure roof is recommended to be symmetrical (square or rectangular) with an

FIGURE 45. Roof construction for strong winds (Image from: Agarwal, 2007)¹¹⁶

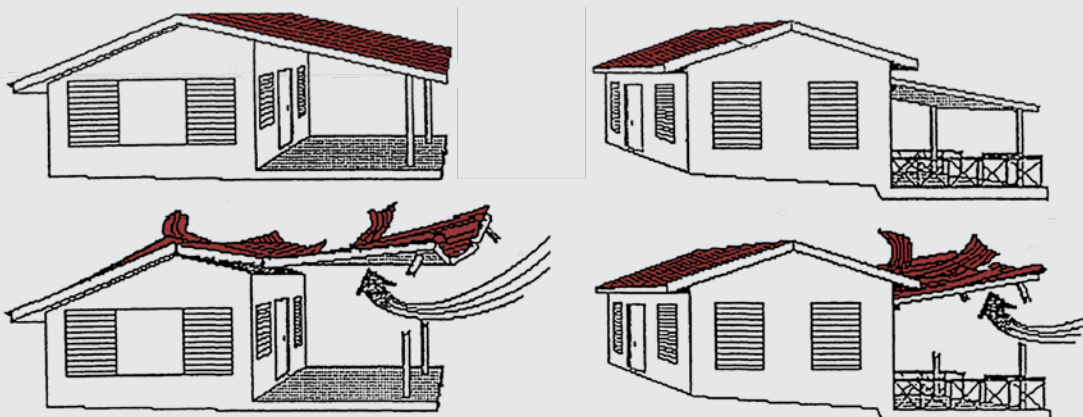

FIGURE 46.

Central shaft (labelled A) with aerodynamic features designed to reduce wind forces during an extreme wind event (Image from Taher, R. 2007)¹⁶¹

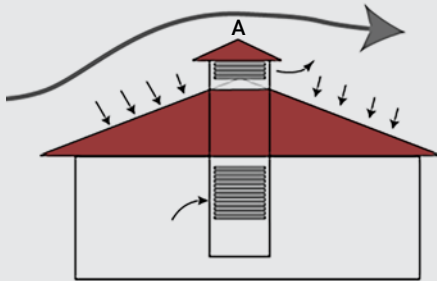
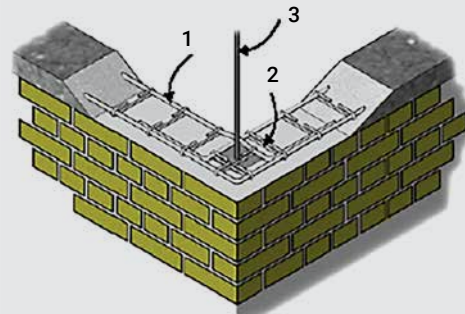

FIGURE 48.

Connection between vertical reinforcement and the seismic band at lintel level (Agarwal, 2007)¹¹⁶



1. Longitudinal reinforcements
2. Lateral Ties
3. Vertical reinforcement as corners

FIGURE 47.

Reinforcing a roof (from: Pérez, 2017).¹⁶³

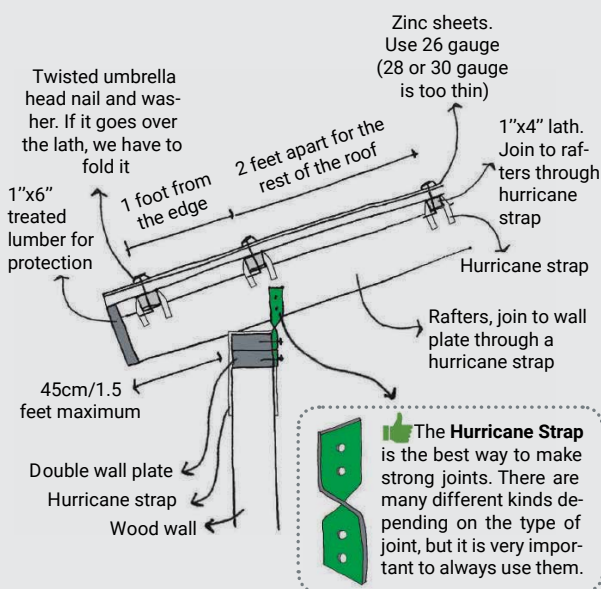

5.3.2 Fastening roofs and walls

Changes to the typical design and construction of a roof and walls can be adjusted to reduce damage from high winds. Collar ties, gussets and metal straps are all recommendations for securing the roof ridge in cyclonic regions. Where galvanized roofing is used, 24-gauge is recommended. When affixing roofing, screws are recommended over nails, and large washers under screw heads should be used to prevent the roof sheets from tearing when pulled upward by high winds. Similar structural construction recommendations used in earthquake-prone areas are also recommended for resistance to high winds. In cyclonic regions, it is recommended to reinforce the walls with reinforced concrete bands and vertical reinforcing bars (see figure 48).¹¹⁶

5.3.3 Building shape

Research on storm resistance is examining the effectiveness of domes and circular-shaped floor plans (see [figure 49](#) and [figure 50](#)). One study concluded that although measured real world data do not exist, simulations and observations from actual cyclonic disasters do suggest that geodesic dome structures suffer far less destruction than rectilinear structures.¹⁶⁴ The hypothesis is that geodesic domes are more energy efficient and more wind resistant the more closely they resemble a hemisphere in form (sphericity). During a natural disaster, trees may also be uprooted and then fall at a tremendous force, landing on the nearest object or structure in their path. When trees hit the roof of a rectilinear home during a hurricane with a 2.4 m vertical wall, the house can be severely damaged. However, damage to the dome home will be minimal because the near hemispherical shape of the geodesic dome will gradually break the fall of the tree in varied increments of degrees.¹⁶⁴

5.4 Material selection^{##}



Generally, the building materials specified in design or used in construction should be chosen from among those available locally. This approach has a number of positive effects including a reduction in both transportation energy and embodied energy; an increased likelihood the local labour force will be familiar with the material; and a greater chance that material will be available for repairs and maintenance needs after construction.

Materials that are sustainably produced or sourced should be prioritized whenever appropriate and possible. It can be helpful to carefully review the sourcing and full life cycle of a building product (which includes disposal or reuse) to ensure that damage to local ecosystems is mitigated or eliminated. Unwise

FIGURE 49. Dome dwellings (Image Source: Rappler.com)



use of local resources can exacerbate vulnerability to the impacts of climate change in addition to negatively impacting biodiversity.

Materials highlighted in this section draw from popular and widely used or recommended products in developing countries, such as those found in [table 3](#).¹⁶⁸ Though rather technical, these tables can provide context and a starting place for discussions with design and construction experts on projects that seek to improve adaptation to climate change.

The materials in column one (Type 1) are typically widely available, of lower cost and require limited training to use. Materials in column two (Type 2) can be assembled on-site and require some skill but are increasingly common. The third column, (Type 3) lists materials that are, perhaps, less common globally than those in the first two approaches and also do require some skill and industrially manufactured supply materials.

As explored in the previous chapters, thermal mass and thermal performance are key measures to ensure a comfortable indoor environment. High thermal mass is best in climates where solar gain can be captured and stored during the day and released at night. It is ideal when the re-radiated heat is usable, but it is also acceptable if the stored heat can be ventilated from the structure at night without overheating the interior environment. Thermal mass should only be incorporated in designs where glazing, shading and ventilation have been optimized to work with the thermal mass. Ideal thermal conductivity and resistance also varies by climate, making it important to confer with local experts to establish what is best for the specific location.

Sand: old material rediscovered

Sand is a highly versatile material that is a key input for concrete. It is also a finite resource, but as cities grow so does the demand. In many areas, harvesting of sand is prohibited. In some, like Cape Verde, military guard now protect this resource and the integrity of the country's beaches. However, as construction continues so does illegal harvesting -much to the detriment of local communities. The loss of sand puts buildings, and lives, at risk from increased riverine flooding, landslides, coastal erosion, and saltwater intrusion farther inland. When sourcing building materials, it is key to ensure their origin, legality, and quality. Further, educating and training the work force will help to minimize both over-use and waste material generation.¹⁶⁷

This section provides a general overview of materials that could or have been used in the climates mentioned above. For more extensive information on materials, refer to¹⁶⁵ Hannula, E.-L., *Going Green*, ed. C. Lalande. 2012, Nairobi: United Nations Human Settlements Programme. See also¹⁶⁶ Gupta, R. and M. Gregg, *Green Building Interventions for Social Housing*, ed. C. Lalande. 2015, Nairobi: United Nations Human Settlements Programme.

TABLE 3. Representative list of common building materials and systems ¹⁶⁸

Established and practiced systems		Emerging systems validated and promoted by BMTPC
Type 1: Readily available in the market	Type 2: On site production based / in-situ	Type 3: Evidence of use in demonstration project on social housing
1. Burnt clay brickwork English bond	7. Stone-crete blocks	13. Glass fibre reinforced gypsum (GFRG) panel system
2. Fly-ash brick masonry	8. Stabilized compressed earth blocks	14. Monolithic concrete building system using plastic/aluminium composite
3. Rat rap bond using burnt clay bricks	9. RCC (reinforced concrete cement) filler slab roof	15. Light gauge steel frame (LGSF) system
4. Solid concrete block masonry	10. Precast RCC plank and joist roof	16. Reinforced EPS core panel system
5. Hollow concrete block masonry	11. Precast ferro-cement channel roof	17. Precast large concrete panel system
6. Aerated autoclave concrete (AAC) blocks	12. Reinforced brick panel roof	

Walling Approaches
 Roofing Types
 Combined approaches (Roofs and walls, etc.)

The table below provides the thermal performance of common approaches used in India (see [table 4](#)) and therefore likely containing materials more generally available around the globe. The noise transmission properties of some of these assemblies are also presented in [table 5](#). Materials that easily transmit noise can make for an indoor environment that is extremely noisy during storm events. This can be particularly dangerous in commercial or public buildings by making it difficult to hear instructions or evacuation orders. As much as possible, materials with a low noise transmission value should be preferred. Sound transmission class (STC) ratings are used to rate a building element. A “good” STC rating depends on the context; however, an STC of 40 allows loud speech to be inaudible but heard by someone outside the room, whereas an STC rating of 65 is considered superior soundproofing.

Detailed in earlier chapters, damages from **flood** and storm events can be long-lasting. Therefore, regardless of climate, where moisture, heavy rains and or flooding are climate risks, water-resistant materials are important. [Table 6](#) provides a list of common materials (from the Australian perspective) and whether they are water-resistant.¹⁶² This list can be used as guidance in identifying appropriate, locally available materials for adaptation projects.

Suggested climate-specific materials

Building materials can be selected based on their availability in certain regions. As an example, wood framing is common in North America and Europe due to its availability through forest management and forestry. However, wood is not a good insulator; therefore, many manufactured insulation materials are also needed in these climates.

Building materials in **cold climates** should reduce heat loss through increased thermal resistance and buffer spaces. Autoclaved cellular concrete (AAC) block walls can save annual heating loads by 26 per

TABLE 4. Thermal performance of select assemblies ¹⁶⁸

Building system	Assembly specifications	U-VALUE W/m ² K	Source
English-bond brickwork (clay work)	225mm burnt clay brickwork in cement mortar, 12.5mm plaster on both sides.	2.13	CARBSE Assembly U-factor calculator.
Fly-ash brick work	230mm fly-ash brick (density – 1240), plaster on both sides.	1.98	Strategies for cleaner walling materials in India'-SHAKTI Foundation (2011)
Rat-trap bond brickwork	230mm masonry, plaster on both sides	1.79	Strategies for cleaner walling materials in India'-SHAKTI Foundation (2011)
Solid concrete block masonry	200mm blocks, 12.5mm plaster on both sides	2.14	Strategies for cleaner walling materials in India'-SHAKTI Foundation (2011)
Hollow concrete block masonry	200mm blocks, 12.5mm plaster on both sides	1.89	Strategies for cleaner walling materials in India'-SHAKTI Foundation (2011)
AAC block masonry	200mm masonry with plaster on both sides	0.7	Strategies for cleaner walling materials in India'-SHAKTI Foundation (2011)
Stone-crete blocks masonry	100mm sandstone, 100mm concrete, 12.5mm plaster on inside face.	3.4	CARBSE Assembly U-factor calculator
CSEB walling	230mm masonry, plaster on both sides	1.94	Strategies for cleaner walling materials in India, Shakti Foundation (2011)
Ferro cement channel roofing	25mm channel roof with 75mm brickbat concrete and 30mm cement screed	2.56	C. Kabre - A new thermal performance index for dwelling roofs in the warm humid tropics. Building and Environment 45(2010) 727-738
RCC filler slab roofing	100mm thick, 12mm plaster on both sides. Filler: mangalore clay tiles of effective thickness of 62mm.	3.94	C. Kabre - A new thermal performance index for dwelling roofs in the warm humid tropics. Building and Environment 45(2010) 727-738
Reinforced brick panel roofing	75mm clay brick with 35mm thick cement mortar on both sides	2.85	CARBSE Assembly U-factor calculator
Pre-cast RCC plank & joist roofing	60mm thick plank, 40mm screed. Effective thickness same as 100mm thick RCC slab.	3.62	C. Kabre - A new thermal performance index for dwelling roofs in the warm humid tropics. Building and Environment 45(2010) 727-738
Reinforced EPS core panel system	150mm thick single panel, includes 70mm EPS core and 40mm shortcrete on both sides.	0.58	BMTPC PACS Manual on Reinforced EPS Core panel System
GFRG panel system	Standard 124mm thick GFRG panel filled with cellular concrete (94mm thick cavity).	2.85 ^{§§§}	FRBL, "Glass fibre reinforced gypsum load bearing panels for affordable housing in fast track & environmental protection"
LGFSFS-ICP	Cold formed LGS frame with 20mm thick M20 precast concrete panel, 89 mm thick lightweight concrete, 10mm plaster on external face.	3.87	CARBSE Assembly U-factor calculator
Precast large concrete panel system	100mm thick panel	2	Compendium of Prospective Emerging Technologies for Mass Housing, Second Edition, BMTPC, April 2017
Monolithic concrete construction	100mm RCC wall or roof	3.59	Technology profile of monolithic concrete construction system using aluminium formwork, BMTPC

^{§§§} The U-value is of the most common construction practice with GFRG. This can vary with the thickness of the cavity.

TABLE 5. Noise transmission of select assemblies ¹⁶⁸

Building system	Noise transmission (dB)	Source
AAC block masonry	45	Source: EcoGreen Products Technical Specifications
220mm brick wall plastered on both sides	50	http://www.bertsbricks.co.za/index.php/Brick-Technical/acoustic-performance-of-brickwork.html
CSEB walling	50	Coefficient of acoustic attenuation for 40 cm thick earth wall at 500 Hz
Reinforced EPS Core Panel System	37	BMTPC PACS Manual on Reinforced EPS Core Panel System
GFRG Panel System	40	Source: Compendium of Prospective Emerging Technologies for Mass Housing, Second Edition, BMTPC, April 2017
Precast Large Concrete Panel system	49	Acoustic Properties of precast concrete panels, National precast society, AU
Monolithic Concrete Construction	45	BMTPC PACS Manual on Monolithic Concrete construction using aluminium/plastic formwork

cent as compared to a brick wall. A plain concrete wall increases the load by 23 per cent and, hence, should be avoided. Insulation of the walls helps improve performance significantly. Furthermore:

- Roofing options with insulation are vital.
- Walls should use insulation to reduce the transfer of heat.
- False ceilings with internal insulation such as mineral wool, wood wool, etc. are feasible for houses in cold climates.
- Aluminium foil is generally used between the insulation layer and the roof to reduce heat loss to the exterior.

- Stone and other durable materials are used for building foundations, and in some parts the heavy materials are used for a base course to prevent moisture. However, the buildings of these regions are generally built on the ground.

Materials in **hot-humid climates** should:

- Reduce heat gain through increased thermal resistance and buffer spaces.
- Promote quick heat loss.
- Minimize humidity through quick dissipation.

TABLE 6. Water resistance of materials

	Water resistant	Non-water resistant
Insulation	Closed cell foam (polystyrene or polyurethane)	Fiberglass, mineral wool, wool, cellulose
Floors	Concrete (bare or coated) Floorboards, durable or treated timber Concrete or clay tile	Particleboard, medium density fibreboard, plywood Ceramic tile
Walls	Fibre-cement, concrete block, durable or treated timber, PVC, brick	Particleboard, plywood
Interior	Concrete block, fibre-cement, durable or treated timber	Plasterboard, plywood, hardboard, softwood, carpet or vinyl, particleboard

Small Island Developing States (SIDS)

Sea-level rise increases in ocean and air temperatures, and global biodiversity loss, greatly impact the lives and livelihoods of SIDS inhabitants. Small islands can come with small markets, which makes improving the resilience and adaptation of the building stock on remote islands doubly difficult.

Limited access to renewable, durable and location-appropriate materials, as well as knowledge and expertise, makes reducing vulnerability of buildings challenging. Compounding this is the economic pressure and demographic change driving higher rates of urbanization, increasing the urban-heat island effect and risks from heat waves.

These added pressures have also impacted the building material markets driving some to over-exploit natural and local products; this further impacts natural systems, like mangroves and dunes, increasing the built environment's vulnerability to storm events and flooding.

Implementing the measures outlined in this note can help reduce risk and vulnerability, but special attention should be paid to ensure local material supply-chains, technical knowledge and expertise are also secured and further developed. Lastly, special attention should be paid during the construction process to ensure protection of coastal ecosystems.^{169, 170}

When properly sheltered from rain, exposed materials with a high absorption rate perform well by absorbing humidity from within the building. As diurnal variation is low, insulation in the roof does not provide high benefits.¹²⁹

Reinforced concrete cement (RCC) filler slab helps increase insulation and reduces heat gain from the roof. Reflective/light paint or the use of broken glazed tiles on the roof surface reduces the heat gain further. Materials with cavities, such as hollow concrete blocks and rat-trap bond, perform better as

they introduce air spaces that act as buffer zones and ventilation points. Water proofing is also an essential step in construction in the warm-humid climate.

Materials in the **hot and dry climate** should minimize heat gain as well as capture and hold solar radiation to be released later where large day and night temperature differences are common.

Materials suitable for hot-dry climate are:

- Autoclaved aerated concrete blocks
- Ferrocement channels (metal mesh combined between layers of concrete)
- Sustainable mine waste such as stones, stone dust and chips to make concrete blocks
- Fly-ash bricks (more efficient if travel is less than 100 km)
- Compressed stabilized earthen blocks
- Hollow core concrete blocks
- Perforated brick masonry, rat-trap bond
- UPVC windows, to provide better insulations in comparison to aluminium windows.
- Marble chips used in manufacturing of terrazzo
- Low VOC paints, adhesive and sealants.
- Sandstone roofing

No matter which material is selected, it is exceptionally critical to ensure quality materials are used. Substandard products such as reinforcement ties, steel sections and low-quality cement greatly contribute to structural failures. Even with the best of intentions and designs, inappropriate materials will compound the risk of building failures. This is a particular risk for vulnerable communities and projects that lack resources, technical skills and knowledge.¹⁷¹

Something to consider:

A study of the Malaysian reconstruction experience found that though timber, as a building material, has the lowest GHG emissions, it generally is not the best choice for buildings that are prone to flooding. A thorough life-cycle assessment and life-cycle costing of five material types found that pre-cast concrete has a lower total GHG impact when factoring in the need for repairs.²

6 Conclusion, recommendations and next steps



This practical guide has presented ideas for unlocking the potential to reduce the vulnerability of buildings and communities to climate risk, with a particular focus on areas of developing countries where structures are largely self-built. It was developed in recognition of a need for additional resources addressing good practices for building design and construction in communities and towns that face risk from disasters but may suffer from a deficit of professionally trained architects, engineers, contractors and other practitioners.

The report first provided understanding of key concepts of vulnerability, disaster risk and resilience in the context of the building sector followed by general approaches to design and construction. Finally, technical design examples were provided for the varied climatic contexts of cold, hot-dry, hot-humid, and composite temperate climates. Concerted efforts were made to provide examples of diverse homes and buildings as socially meaningful and creative extensions of culture and personality. Such diversity in built form exemplifies that buildings do not need to be bunkers or bomb shelters to be safer. Vulnerability can be reduced through greater planning and implementation and further development of the ideas and technical measures discussed in this report, as summarized below (see [table 7](#)). The key ideas and approaches presented in this report were:

- **Resilient people = resilient buildings:** When applying the design concepts and approaches to buildings, additional care and attention should be paid to the needs of its inhabitants and building users of all ages, gender, financial means and physical ability. This ensures equitable reductions of risk and vulnerability (see [section 2.1 in chapter 2](#)).
- **Whole-of-life/life-cycle approach to building design:** Make decisions carefully. Our buildings can and will last for a long time, so it is critical to carefully consider where and how development occurs, which materials are used, and how buildings are designed and oriented on the site. Decisions made today will be locked-in for the life of building and even at end of building's life (including considerations of how the building will be dismantled and its materials separated for reuse, that is, resource efficiency).
- **Locally rooted design and construction solutions:** There are a variety of design, material choices, construction skills and construction implementation approaches, as

evidenced by the examples explored earlier. It is critical to adapt these to the local context - not only in adjusting roof overhang or external shading angles based upon distance from the equator, but also by considering local labour conditions, local ecosystem health, material availability and supply chains to promote a circular economy. Reducing vulnerability entails providing the proper training and skills development of communities and raising their awareness and knowledge of how to apply and maintain new products. Consider how the local availability of some natural materials may also change because of demand but also because of a warming climate.

- **Government good will:** There is only so far individuals, or one sector, can go in addressing climate adaptation and disaster risk reduction. Governments must promote an enabling environment for adaptation measures to be successfully implemented in the building and construction sector. Adaptation at-scale will not be possible without government good will in making necessary changes to building standards; promoting risk awareness; subsidizing adaptation measures in the existing building stock; and promoting skills training in the construction sector.

One way to demonstrate leadership and support risk reduction in buildings is to expand and revise building codes, as explored in (see [section 3.2.2 in chapter 3](#)). When revising existing or adopting new building codes, consideration needs to be given to how buildings are constructed (see [chapter 4](#) and [chapter 5](#)); which materials are used (see [section 4.6 in chapter 4](#) and [section 5.4 in chapter 5](#)); and the design of the site (see [section 4.1](#) and [section 4.2 in chapter 4](#)), the building and its systems. All of these things impact energy and water consumption as well as vulnerability. Building codes should also



be based upon the twin foundations of accurate historical climate data and future climate projections. This helps to ensure that new buildings can adapt to the changing climate. For success, building codes should be broadly disseminated and taught. They should be enforced through inspections, and supporting policies and practices should be put into place (fines, permitting, technical reviews, etc.).

- **Designing adaptable buildings for an uncertain future:** This is potentially the most challenging aspect of all. The design approaches and principals included in this report can be applied, following the “No Regrets” approach. Measures taken today to improve the resilience of a building to a changing climate will provide benefit even if uncertainty remains over the exact degree of warming or climate change that may be realized in the future. One must not only consider measures that reduce vulnerability today, but also think about the challenges of

the future. That may mean planting trees and planning green space to provide greater shade and micro-cooling in the warmer climate of our future, and also including those steps needed to recover, rebuild and strengthen communities after climate-related hazards. Areas that are temperate at present may become hot and humid in near future. Consequently, designing for multiple future scenarios is where “adaptable” design can become most important.

6.1 Next Steps

Identifying design ideas and potential technical approaches to reduce vulnerability according to local context is a key first step. In addition, government officers, adaptation specialists and development practitioners will benefit from considering the following points as well as the suggestions identified in [table 7](#), below, before undertaking a new project.

1) What are the current local climatic conditions and the expected future conditions triggered by global climate change? Knowing how a building’s design or use addresses the current and expected future climate conditions is of high importance:

- a. Is the area in a hot and humid, hot and arid, temperate or other type of climate zone?
- b. What are the daily temperatures and expected future changes (cooling-degree days, heating-degree days)?
- c. What are the current and expected changes in precipitation (increased or decreased rainfall, water shortages, flooding, etc.)?
- d. What – if any - impacts are expected from sea-level rise (flooding, storm surge and availability of freshwater)?

2) What are the current and future climate change-related risks at the project site?

- a. Is there a better site for the project? One that has fewer expected hazards?
- b. If the site cannot be moved or the hazard avoided, what is the magnitude of the hazard (including top wind-speeds, flood line, etc.)? Knowing this will be critical in selecting a more appropriate building design approach.

3) Is the building location optimized?

- a. Is the site designed to minimize flood or other climate risks (heat wave, sea level rise etc.)?
- b. Has the site taken full advantage of available nature-based solutions for solar gain, shading and natural ventilation or drainage (trees, landscaping, etc.)?
- c. Does the building’s design approach fully utilize tools for mitigating flood risk (room layout, material selection)?

- d. Is the building oriented to minimize unwanted heat gain and take advantage of shading and natural wind flow (louvres, roof overhang, etc.)? Remember to ensure the design is appropriate for the hemisphere and distance from the equator (north-facing or south-facing).

4) Do the key building design elements, such as walls, roofs and the internal layout of spaces, adequately respond to current and expected future needs (warming, precipitation, etc.) and expected hazards, such as high winds?

- a. Is the roof optimized for shading? Reducing heat-gain? Resisting or mitigating damage from strong winds? (Reminder: this can include the roof's shape, materials used and also the construction methods).
- b. Are the walls sufficiently designed for minimizing unwanted heat loss or gain? Resisting or mitigating wind and water damage?
- c. Is the layout (placement of rooms) optimized for natural ventilation and managing heat or cold? For safety? (Are bedrooms above flood elevation, for example?)

5) Are the most appropriate materials and methods selected?

- a. Is there sufficient local capacity for the installation and maintenance of the materials and/or construction practices? Or is more knowledge and training needed?
- b. Does the building utilize materials or methods that can mitigate or reduce risk, such as wet-dry construction? Design for re-construction? Frangible or triage design approaches?
- c. Are the materials sustainably and locally sourced? Are the chosen materials most appropriate for the local climate (including thermal performance, strength, recyclability)?

Beyond the building-specific questions above, and equally important to ensure success, is the need to strengthen, develop and incorporate local knowledge and capacity within the community. It is often assumed that markets in developing countries lack access to appropriate materials for construction, and this is why buildings fail when facing hazards. Often, however, this is not the key reason for the vulnerability of their built environment. The culprits are frequently failures to knowledgeably monitor and inspect the construction; the misuse or misapplication of tools, materials and techniques; or even just not giving enough time to the process (such as not allowing concrete to fully cure before proceeding with construction).¹⁷¹ Coupling international support (knowledge, materials, technologies) with local



resources, knowledge and skills builds capacity, lowers vulnerability, improves resilience and maximizes the benefits from donor investments.¹⁷²



Future work on this topic can benefit from additional engagement of national or local experts with community leaders, social networks and other community organizations. There is great benefit when international and national experts enhance engagement and collaboration of local communities. Projects that fully engage result in communities with higher levels of trust and a greater transfer of knowledge and skills.¹⁷³ When all are working together, the communities will plant and nurture seeds for long-lasting reductions of vulnerability for all at-risk populations.

TABLE 7.

Summary of adaptive approaches by climate impact and sphere of construction (Adapted from: L. Amitrano et al., 2007; Gupta & Gregg, 2011)^{72, 135}

Climate change impact	Building design	Planning/ external factors
<p>Increased temperature averages and extremes (e.g. heatwaves)</p> 	<p>ALL CLIMATES:</p> <ul style="list-style-type: none"> - Control solar gain through site or building changes: green roofs, white roofs, ventilated roofs, integrated green cover on walls, internal and external manufactured shading devices. - Provide adequate insulation and ventilation (natural ventilation, ceiling fans, raised structure where appropriate). - Decrease lighting and equipment loads. <p>HOT CLIMATES:</p> <ul style="list-style-type: none"> - Maximize external wall areas (plans with one room depth are ideal) to encourage movement of breezes through the building (cross-ventilation). - Ventilate roof spaces. - Include high ceilings and other design features for natural ventilation. - Arrange multiple buildings to benefit from mutual shading. - Shade whole building summer and winter (consider using a fly roof or other roof shading strategy). Minimize east and west openings. - Consider lightly coloured roof, walls, and surrounding paving (high albedo). - Provide screened, shaded outdoor living areas to provide additional relief from heat. <p>HOT – HUMID</p> <ul style="list-style-type: none"> - Use materials which reduce heat gain, provide fast heat loss, and minimizes humidity. - Limit the number of large, glazed windows. - Fewer windows can be helpful in humid climates. - Openings to buildings should avoid direct sun. <p>HOT-DRY:</p> <ul style="list-style-type: none"> - Use thermal massing with natural ventilation, such as: - Install convective (stack) ventilation, which vents rising hot air while drawing in cooler air. - Use materials which minimize heat gain and capture solar radiation where diurnal temperature ranges are high. - Use wind towers or earth air tunnels - Arrange multiple buildings to benefit from mutual shading. <p>HOT-DRY</p> <ul style="list-style-type: none"> - Use thermal mass, i.e. use lightweight construction where diurnal (day/night) temperature range is low and include thermal mass where diurnal range is significant. - Provide insulation with a proficient vapour barrier. - Use window shading (louvres) to minimize heat-gain. - Consider using Trombe or water walls and solar chimneys. <p>COLD:</p> <ul style="list-style-type: none"> - Manage shading to allow solar gains in winter. - Where heat gain is desirable, locate buildings on southern slopes (northern hemisphere), exposure to cold winds can be minimized by placing buildings on the leeward side. Consider ventilation and solutions to prevent heat-loss at exit points. - Provide insulation with a proficient vapour barrier. - Place windows to facilitate heat gain. - Consider using Trombe or water walls and solar chimneys 	<p>ALL CLIMATES:</p> <ul style="list-style-type: none"> - Consider orientation of building (longer walls facing north and south) and placement of surrounding geographic features, trees, and structures to capture and direct wind flow and control solar gain. - Implement efforts to strengthen social connectivity, community capacity, skills and networks. <p>HOT CLIMATES</p> <ul style="list-style-type: none"> - Increase green space for microclimate cooling, including landscape (green infrastructure). - Use garden ponds and water features to provide evaporative cooling (blue infrastructure). - Provide access to external shaded space for overheating relief (also important in cold climates, as buildings designed for the cold climate can be most ill-equipped to cope with high temperature extremes). - Install rainwater collection systems. <p>COLD CLIMATES:</p> <ul style="list-style-type: none"> - Make streets wide enough to prevent shading.

Climate change impact	Building design	Planning/ external factors
<p>Increased water stress/wildfire risk</p> 	<p>ALL CLIMATES:</p> <ul style="list-style-type: none"> - Use fire-resistant building materials. - Install building fire suppression systems (sprinklers) in high-risk zones. - Provide for emergency irrigation of surrounding landscaping to reduce fire risk (link with rainwater collection system). 	<p>ALL CLIMATES:</p> <ul style="list-style-type: none"> - Plan drought resistant ground shading plants to retain ground moisture. - Install rainwater collection systems. - Balance the need to plant vegetation for cooling and shading with the need to clear at-risk vegetation. (Potentially problematic for shading and reduction of UHI) - Consider alternative building elements to replace lost site shading, e.g. traditional fabric courtyard coverings or a raised PV system that remains open underneath)
Storms, floods and sea-level-rise		
Climate change impact	Building design	Planning/ external factors
<p>More intense storms with high speed winds and driving rain, e.g. cyclones</p> 	<p>ALL CLIMATES:</p> <ul style="list-style-type: none"> - Consider frangible architecture options. - Apply a “triage” approach to building design and construction and consider Design for Deconstruction (DfD). - Raise the house above flooding levels. - Use rectangular or square roofs with multiple slopes (hip roof) and sufficient gradient. - Build circular or geodesic-shaped houses, e.g., domes. - Upgrade fasteners in roof structures and in sub-floor. - Ensure weathertightness (sealing corners, holes, unintended entry points for wind or rain) and drainage detailing (routing water away from the building as quickly as possible through sloped drainage pipes). - Limit overhangs on roofs. - Use water-resistant materials. 	<ul style="list-style-type: none"> - Avoid cyclonic areas. - Consider orientation of building and placement of surrounding geographic features, trees and structures to capture and direct wind flow. - Install warning systems. - Promote efforts to strengthen social connectivity, community capacity, skills and networks.
<p>Hail events</p>	<p>ALL CLIMATES:</p> <ul style="list-style-type: none"> - Use impact-resistant roofing materials. - Design more appropriate window protection. - Install protection of externally fitted services and fixtures, such as PV. 	

Climate change impact	Building design	Planning/ external factors
<p>Flooding and increased concentration of rain events</p> 	<p>ALL CLIMATES:</p> <ul style="list-style-type: none"> - Consider frangible architecture options. - Increase repair drainage capacity with or without integrated green infrastructure. Consider flood barriers / raised entry threshold. - Plan for higher placement of electrical, ventilation and heating systems. - Use moisture-resistant materials. - Design for de-/ re-construction. - Elevate building so finished floor is above flood plain. - Implement systems for rainwater collection and use, consider stormwater control through green roofs. - Use sloped roofs instead of flat roofs. 	<ul style="list-style-type: none"> - Avoid flood-prone areas. - Improve land-use and site management. Plant trees to improve soil stabilization. - Improve permeation of water into the ground <ul style="list-style-type: none"> - reduce hard surfaces and increase provision of pervious and/or semi-pervious surfaces such as vegetation, pebble beds and porous pavements/ reduction of hard surfaces. - Use nature-based solutions (NbS), such as the planting of trees, to improve soil stability. - Consider including flood gates. - Consider including green infrastructure such as sustainable drainage systems. - Develop early warning systems and prepare evacuation plans. - Promote efforts to strengthen social connectivity, community capacity, skills, and networks.
<p>Sea-level rise</p> 	<p>ALL CLIMATES:</p> <ul style="list-style-type: none"> - Design for de-/ re-construction - Construct buildings above ground - Use wet-dry architectural approaches, including selection of water and salt resistant materials 	<ul style="list-style-type: none"> - Avoid coastal areas. - Use nature-based solutions to reduce storm surge, such as mangroves.



7 Additional resources

Title	Source	Description
Building regulation for resilience managing risks for safer cities	World Bank	Low- and middle-income countries will experience a doubling of their building stocks in the next 15- 20 years, and it is crucial to assure that this new construction does not recreate and expand the disaster vulnerability of the present. Priority must be placed on the production of safe and resilient cities, communities and homes. While safer, code-compliant construction may add to initial construction costs, these investments can be balanced against the reduced loss of life and property in future disasters.
A review of climate change implications for built environment: Impacts, mitigation measures and associated challenges in developed and developing countries	Hamad Bin Khalifa University	This interdisciplinary review organizes, summarizes and critically analyses the literature regarding the nexus between climate change and the built environment, its associated impacts, and the proposed mitigation measures and challenges for their implementation. While global warming-driven changes of ecosystems could have multiple impacts on the built environment (most prominently on building energy demand and related urban energy systems), the building sector presents significant potential for climate change mitigation.
Key findings from the Intergovernmental Panel on Climate Change (IPCC) Fifth Assessment Report (AR5) on Buildings	IPCC	It is now corroborated that the world's buildings account for a large share of the global final energy use and greenhouse gas (GHG) emissions. This overview of the key findings stresses the major role of buildings in effectively addressing climate change and shows the need for stronger building codes. There is major potential for energy savings of up to 50%–90% in existing and new buildings.
Resilience and Resource Efficiency in Cities	UN Environment Programme	This report looks at the relationship between building the resilience of cities in the face of global environmental change and increasing the resource efficiency of cities to reduce their harmful impacts on the environment. It provides examples of effective ways to address these agendas, as well as the potential and challenges for integration.
Sheltering from a Gathering Storm: Flood Resilience in India	Institute for Social and Environmental Transition-International	This report focuses on key issues related to housing in Gorakhpur, India, and provides insights into the economic and non-financial returns of adaptive, resilient shelter designs that take into consideration hazards such as flooding and temperature increases.
SHERPA for Sustainable Housing Projects	UN Habitat and One Planet Network	SHERPA is a free-to-use online assessment tool for evaluating sustainable housing. It can be used in support of the design, construction and planning of housing projects.
Available technologies for local building materials	International Centre for Science and High Technology	This report provides a broad survey of available technologies for the development and implementation of local building materials. It covers low-cost, LCA, as well as a number of case studies.
Nature-based Solutions for Building Resilience in Towns and Cities: Case Studies from the Greater Mekong Subregion	Asian Development Bank	"This publication summarizes the rich seven-volume "Resource Kit on Building Resilience and Sustainability in Mekong Towns."2 It includes the principles of green infrastructure and measures for building resilience; nature-based solutions of special relevance to Mekong towns, grouped into four categories of water and flood management, slope stabilization, and pollution management; the urban planning and management framework required for mainstreaming of green infrastructure, in particular, the role of town master planning and zoning schemes; the process for conducting vulnerability assessment; and includes case studies"
MaS-SHIP Mainstreaming Sustainable Social Housing in India Project	One Planet Network	Online resource for improving the environmental performance of social housing in India. Contains case studies, resources, reports, and recommendations.
Disasters and the Built Environment	CIB	The roadmap has been largely drawn from the series of the webinars that shared knowledge and expertise between CIB, UNISDR, and cities that are involved in the 'Making Cities Resilient' Campaign.

Title	Source	Description
Bioclimatic Architecture in Warm Climates: A Guide for Best Practices in Africa	Springer and Associates	"This book provides a comprehensive approach to building design. Bioclimatic design is key to urban sustainability and a critical issue in Africa where many building types were 'imported.'"
Energy Efficient Building Design: Nigeria	GIZ-Nigeria Energy Support Programme	The report provides an overview of building physics for architects and engineers. It focuses on the building envelope and thermal balance; thermal flow; properties of materials and how to identify and select appropriate materials and components.
Tracking Buildings 2020	IEA	Report outlining Climate Change Impacts on Buildings
Policy Database	IEA	Policy and Building Code Database
Climate Change Adaptation Design Resources	American Institute of Architects	Collection of resources to help prepare buildings to handle climate changes. Includes examples, resources, simulation tools to assist with the visualization of environmental impacts on buildings, and case studies.

References



Lucena City, Quezon, Philippines - October 11, 2020: Over water stilt Bajau shanty houses built by indigenous people in the Philippines. Long shot
© iStock.com

1. Andrić, I., M. Koc, and S.G. Al-Ghamdi, *A review of climate change implications for built environment: Impacts, mitigation measures and associated challenges in developed and developing countries*. Journal of cleaner production, 2019. 211: p. 83-102.
2. Balasbaneh, A.T., A.K. Bin Marsono, and A. Gohari, *Sustainable materials selection based on flood damage assessment for a building using LCA and LCC*. Journal of Cleaner Production, 2019. 222: p. 844-855.
3. Xu, T., et al., *Optimal adaptation pathway for sustainable low impact development planning under deep uncertainty of climate change: A greedy strategy*. Journal of Environmental Management, 2019. 248.
4. Aleksić, J., et al. *Housing and Climate Change-related Disasters: A Study on Architectural Typology and Practice*. In Procedia Engineering. 2016.
5. Dhaka, S., et al., *Assessment of thermal environmental conditions and quantification of thermal adaptation in naturally ventilated buildings in composite climate of India*. Building and Environment, 2015. 86: p. 17-28.
6. Cavan, G., et al., *Urban morphological determinants of temperature regulating ecosystem services in two African cities*. Ecological Indicators, 2014. 42: p. 43-57.
7. *A marooned elderly couple stands on a log close to their home surrounded by high waters in Khulna on May 4, 2019, as Cyclone Fani reached Bangladesh*. © iStock.com
8. Yinxue, L., *Reviews of Sponge City in China*. New Water Policy and Practice, 2017. 4.
9. UNISDR, *The Human Cost of Weather-Related Disasters 1995-2015*. 2015.
10. Field, C.B., et al., *Managing the risks of extreme events and disasters to advance climate change adaptation: special report of the intergovernmental panel on climate change*. 2012: Cambridge University Press.
11. Ritchie, H. and M. Roser, *Natural disasters*. Our World in Data, 2019.
12. UN-DESA, *World Urbanisation Prospects -2014 Revision*. 2014, United Nations Department of Economic and Social Affairs.
13. UN DESA, *World Economic and Social Survey 2016: Climate Change Resilience: An Opportunity for Reducing Inequalities, in World Economic and Social Survey 2016*. 2016, United Nations Department of Economic and Social Affairs: New York. p. 177.
14. UNISDR (2019) *Terminology on disaster risk reduction*. Accessed 26 Aug 2019, from <https://www.unisdr.org/we/inform/terminology>
15. Blaikie, P., et al., *At Risk: Natural hazards, people's vulnerability and disasters*. 1994, Routledge: London, UK.
16. Trundle, A. and D. McEvoy, *Honiara Urban Resilience & Climate Action Plan*. 2016.
17. UNDRR, *Build Back Better: in Recovery, Rehabilitation, and Reconstruction*. 2017, UNDRR.
18. Ahmed, I., *An overview of post-disaster permanent housing reconstruction in developing countries*. International Journal of Disaster Resilience in the Built Environment, 2011. 2(2): p. 148-164.
19. Aquilino, M.J., *Beyond Shelter: Architecture for Crisis*. 2011, London: Thames & Hudson.
20. Barenstein, J.D. and S. Iyengar, *India: From a culture of housing to a philosophy of reconstruction, in Building back better: Delivering people-centred housing reconstruction at scale*, M. Lyons, T. Schilderman, and C. Boano, Editors. 2010, Practical Action: Warwickshire, UK. p. 163-190.
21. Davis, I., *Shelter After Disaster*. 1978a, Oxford, England: Oxford Polytechnic Press.
22. Davis, I., *What have we learned from 40 years' experience of Disaster Shelter?(perspective)(Report)*. Environmental Hazards, 2011. 10(3): p. 193(20).
23. Lyons, M., T. Schilderman, and C. Boano, *Building back better: Delivering people-centred housing reconstruction at scale*. 2010, Warwickshire, UK: Practical Action. xi, 375.
24. Schilderman, T. and E. Parker, *Still Standing? Looking back at reconstruction and disaster risk reduction in housing*, ed. T. Schilderman and E. Parker. 2014, Warwickshire, UK: Practical Action.
25. Vahanvati, M., *A novel framework for owner driven reconstruction projects to enhance disaster resilience in the long term*. Disaster Prevention and Management, 2018. 27(4): p. 421-446.
26. Chambers, R., *Rural Development: Putting the last first*. 1983, Florence: Taylor and Francis.
27. Chambers, R. and G.R. Conway *Sustainable Rural Livelihoods: Practical Concepts for the 21st Century*. Institute of Development Studies Discussion Paper 1992. 296.
28. Development Alternatives, *Sustainable Habitat and Livelihoods for the Poor: Strategic imperatives and practical solutions, in IInd International basin Conference, India*, DevelopmentAlternatives, Editor. 2004: New Delhi, India.
29. Development Alternatives. *About Us*. 2011a [cited 2012 08 May]; Available from: www.devalt.org/about_us.aspx.



30. Sen, A., *Development as freedom: An India perspective*. Indian Journal of Industrial Relations, 2006. 42(2): p. 157.
31. Vahanvati, M., *Participation for disaster resilience: A life cycle approach to reconstruction projects in India*, in *Community Engagement in Post-Disaster Recovery*, G. Marsh, et al., Editors. 2017, Routledge Taylor and Francis Group: Abingdon, UK.
32. CRED EM-DAT and UNISDR, *Economic losses, Poverty & Disasters 1998-2017*, in CRED. 2018, CREDCrunch: Brussels.
33. World Bank Group, *Building Regulation for Resilience: Managing Risks for Safer Cities*. 2015: World Bank.
34. IFRC, *World Disasters Report 2004 - From risk to resilience - helping communities cope with crisis*, IFRC, Editor. 2004, International Federation of Red Cross & Red Crescent Societies (IFRC): Geneva.
35. IFRC, *A framework for community safety and resilience*, IFRC, Editor. 2008b, International Federation of Red Cross and Red Crescent Societies (IFRC): Geneva.
36. UNISDR, *Sendai Framework for Disaster Risk Reduction 2015-2030* 2015, UNISDR (United Nations Office for Disaster Risk Reduction): Geneva, Switzerland.
37. Davis, I., P. Thompson, and F. Krimgold, *Shelter after disaster*. 2nd ed, ed. Pa.e. Thompson, et al. 2015, Geneva, Switzerland: International Federation of Red Cross and Red Crescent Societies.
38. Arnstein, S.R., *A Ladder Of Citizen Participation*. Journal of the American Institute of Planners, 1969. 35(4): p. 216-224.
39. Ganapati, N.E. and S. Ganapati, *Enabling Participatory Planning after Disasters: A case study of the World Bank's Housing Reconstruction in Turkey*. Journal of the American Planning Association, 2009. 75(1): p. 41-59.
40. Lyons, M., *Can large-scale participation be people-centred? Evaluating reconstruction as development*, in *Building back better: Delivering people-centred housing reconstruction at scale*, M. Lyons, Editor. 2010, Practical Action: Warwickshire, UK. p. 39-62.
41. Mulligan, M. and Y. Nadarajah, *Rebuilding communities in the wake of disaster: Social recovery in Sri Lanka and India*. 2012, New Delhi: Routledge India. xx, 231.
42. Oliver-Smith, A., *Anthropological Research On Hazards And Disasters*. Annual Review of Anthropology, 1996. 25(1): p. 303-328.
43. Neumayer, E. and T. Plümper, *The gendered nature of natural disasters: The impact of catastrophic events on the gender gap in life expectancy, 1981–2002*. Annals of the Association of American Geographers, 2007. 97(3): p. 551-566.
44. Dhungel, R. and R.N. Ojha, *Women's empowerment for disaster risk reduction and emergency response in Nepal*. Gender & Development: Post-disaster Humanitarian Work, 2012. 20(2): p. 309-321.
45. Ginige, K., D. Amaratunga, and R. Haigh, *Tackling Women's Vulnerabilities through Integrating a Gender Perspective into Disaster Risk Reduction in the Built Environment*. Procedia Economics and Finance, 2014. 18(C): p. 327-335.
46. Smyth, I., *Gender in Climate Change and Disaster Risk Reduction, Manila, October 2008*. Development in Practice, 2009. 19(6): p. 799-802.
47. Raju, E., *Gender as fundamental to climate change adaptation and disaster risk reduction: Experiences from South Asia*. 1 ed, ed. C. Kinnvall and H. Rydstrom. 2019: Routledge. 122-137.
48. UNISDR, *Gender Responsive Disaster Risk Reduction*. 2015, UNISDR (United Nations Office for Disaster Risk Reduction): Geneva, Switzerland.
49. UNDP, *Gender, adaptation and disaster risk reduction, in Gender and Climate Change*, UNDP, Editor. 2016, United Nations Development Programme: New York, USA.
50. KM Asad/ZUMA Wire/Alamy Live News
51. Allwood, J., et al., *Glossary, Acronyms, and Chemical Symbols in In IPCC. Climate Change 2014: Mitigation of Climate Change. Contribution of Working Group III to the Fifth Assessment Report of the Intergovernmental Panel on Climate Change*. 2014, Cambridge University Press: Cambridge, UK New York, NY, USA.
52. Schweiker, M. *Rethinking resilient comfort – definitions of resilience and comfort and their consequences for design, operation, and energy use*. in *11th Windsor Conference: Resilient comfort*. 2020. Windsor, England.
53. Trebilcock-Kelly, M., J. Soto-Muñoz, and L. Marin-Restrepo. *Adaptive thermal comfort for resilient office buildings*. in *Journal of Physics: Conference Series*. 2019. IOP Publishing.
54. Short, C.A., et al., *Building resilience to overheating into 1960's UK hospital buildings within the constraint of the national carbon reduction target: Adaptive strategies*. Building and Environment, 2012. 55: p. 73-95.
55. Lomas, K.J. and R. Giridharan, *Thermal comfort standards, measured internal temperatures and thermal resilience to climate change of free-running buildings: A case-study of hospital wards*. Building and Environment, 2012. 55: p. 57-72.
56. Wolff, C., D. Schroeder, and M. Young, *Effect of improved housing on illness in children under 5 years old in northern Malawi: cross sectional study*. BMJ (Clinical research ed.), 2001. 322: p. 1209-12.

57. IPCC, A.W., *Climate change 2013: The Physical Science Basis—summary for Policymakers*. 2013. p. 36.
58. Vahanvati, M., Disaster season is here: Have you got your resilience action plan? *The Conversation*, Australia. 2021.
59. Raymond, C., T. Matthews, and R.M. Horton, *The emergence of heat and humidity too severe for human tolerance*. *Science Advances*, 2020. 6(19): p. eaaw1838.
60. De Wilde, P. and D. Coley, *The implications of a changing climate for buildings*. 2012, Elsevier.
61. Commission, E. *Adaptation to Climate Change - Sectors affected*. n.d.; Available from: https://ec.europa.eu/clima/policies/adaptation/how/sectors_en#tab-0-0.
62. Triana, M.A., R. Lamberts, and P. Sassi, *Should we consider climate change for Brazilian social housing? Assessment of energy efficiency adaptation measures*. *Energy and Buildings*, 2018. 158: p. 1379-1392.
63. Wahlstrom, M. and D. Guha-Sapir, *The human cost of weather-related disasters 1995–2015*. Geneva, Switzerland: UNISDR, 2015.
64. Freedman, A. *Australia Is Being Ravaged by The Worst-Ever Heatwave, And That Says a Lot*. *Washington Post*, 2019.
65. Aflaki, A., et al., *Urban heat island mitigation strategies: A state-of-the-art review on Kuala Lumpur, Singapore and Hong Kong*. *Cities*, 2017. 62: p. 131-145.
66. Vahanvati, M., Keating, A. and Cheng, H. *How design of our cities is amplifying urban heat and what to do about it*, in *The Fifth Estate*. 2020, The Fifth Estate: Australia. 2020.
67. Crichton, D., F. Nicol, and S. Roaf, *Adapting buildings and cities for climate change*. 2009: Routledge.
68. Hulme, D., et al., *Urban poverty and climate change: life in the slums of Asia, Africa and Latin America*. 2018.
69. Poplak, R., *What's Actually Behind Cape Town's Water Crisis*, in *The Atlantic*. 2018.
70. Karthikeyan, D., *'Our whole life is disrupted': hope dries up as Chennai battles historic drought*. *The Guardian*, 2019.
71. Corti, T., et al., *Drought-induced building damages from simulations at regional scale*. *Natural Hazards and Earth System Sciences*, 2011. 11(12): p. 3335-3342.
72. Amitrano, L., et al., *An assessment of the need to adapt buildings for the unavoidable consequences of climate change*. Report for Victorian Department of Sustainability and the Environment, 2007.
73. Burton, J., *'It was a line of fire coming at us': South West firefighters return home*, in *Busselton-Dunsborough Mail*. 2020: Australia.
74. Gramling, C., *Australia's wildfires have now been linked to climate change*. *Science News*, 2020.
75. Bryson, M., G. Fletcher, and L. Rodgers, *Cyclone Idai: How the storm tore into southern Africa*, in *BBC*. 2019.
76. Zacarias, A., *'The First City Completely Devastated by Climate Change' Tries to Rebuild after Cyclone Idai*, in *Inter Press Service*. 2019: Maputo.
77. Ayyub, B. and M. Kearney, *Sea level rise and coastal infrastructure: Prediction, risks, and solutions*. 2012. 1-184.
78. Azevedo de Almeida, B. and A. Mostafavi, *Resilience of infrastructure systems to sea-level rise in coastal areas: Impacts, adaptation measures, and implementation challenges*. *Sustainability*, 2016. 8(11): p. 1115.
79. Roschetzky/iStock
80. Fuchs, R., *Cities at Risk: Asia's Coastal Cities in an Age of Climate Change*, in *AsiaPacific Issues*. 2010: Honolulu: East-West Center.
81. Lakritz, T., *These 11 sinking cities could disappear by 2100*, in *World Economic Forum*. 2019.
82. Wilk, K. *Hazards for buildings and structures caused by flood conditions*. in *E3S Web of Conferences*. 2018. EDP Sciences.
83. Lamothe, D.-N., et al., *Evaluation of the impact of floods and associated protection policies (Final report)*. European Commission, DG Environment, 2005.
84. Nicholls, R., et al., *Developing a holistic approach to assessing and managing coastal flood risk*, in *Coastal Risk Management in a Changing Climate*. 2015, Elsevier. p. 9-53.
85. NSSL. *Severe Weather 101*. n.d.; Available from: <https://www.nssl.noaa.gov/education/svrwx101/floods/types/>.
86. Amitrano, L., et al., *An Assessment of the Need to Adapt Buildings for the Unavoidable Consequences of Climate Change*, B. Limited, Editor. 2007, BRANZ Limited: Canberra. p. 85.
87. Shanmugasundaram, J., et al., *Cyclone damage to buildings and structures—a case study*. *Journal of Wind Engineering and Industrial Aerodynamics*, 2000. 84(3): p. 369-380.
88. Sen, A., *Ingredients of Famine Analysis: Availability and Entitlements*. *The Quarterly Journal of Economics*, 1981. 96: p. 433.
89. Vahanvati, M., *Thesis: Owner-driven housing reconstruction as a means of enhancing disaster resilience of at-risk*



communities in India. 2018, RMIT University: Melbourne, Australia.

90. Auld, H., *5.6 THE CHANGING CLIMATE AND NATIONAL BUILDING CODES AND STANDARDS*.
91. DEFRA, G.B.D.f.E., Food Rural, Affairs, *The national adaptation programme and the third strategy for climate adaptation reporting*. 2018.
92. Communities and Local Government, *Code for Sustainable Homes: A step-change in sustainable home building practice*. 2010, United Kingdom Government: United Kingdom.
93. ASC, C., *Managing climate risks to well-being and the economy*. Committee on Climate Change, London, 2014.
94. Sun, X., et al., *Mandating better buildings: a global review of building codes and prospects for improvement in the United States*. WIREs Energy and Environment, 2016. 5(2): p. 188-215.
95. APEC, *APEC Building Codes, Regulations, and Standards: Minimum, Mandatory, and Green*. 2013, US AID, APEC.
96. Nicol, F., M. Humphreys, and S. Roaf, *Adaptive thermal comfort: principles and practice*. 2012: Routledge.
97. Vahanvati, M. and B. Beza, *Owner-Driven Reconstruction in India: A case-study of Kosi River Floods in Bihar*, in *5th International conference on building resilience*. 2015: Newcastle, Australia.
98. Jha, A.K., et al., *Safer Homes, Stronger Communities: A Handbook for Reconstructing after Natural Disasters*. 2010, World Bank: Washington, DC
99. Hunnarshala. *Three themes - Community driven housing*. 2007 [cited August 2012; Available from: www.hunnarshala.org/about-us.html].
100. Schilderman, T. and M. Lyons, *Resilient dwellings or resilient people? Towards people-centred reconstruction.(research paper)(Report)*. Environmental Hazards, 2011. 10(3): p. 218(14).
101. Hamdi, N., *Foreword*, in *Building back better: Delivering people-centred housing reconstruction at scale*, M. Lyons, T. Schilderman, and C. Boano, Editors. 2010, Practical Action: Warwickshire, UK. p. ix-xi.
102. Barenstein, J.D. *Housing reconstruction in post-earthquake Gujarat: A comparative analysis*. Network Paper, 2006. 54.
103. Barakat, S. *Housing Reconstruction After Conflict and Disaster*. Humanitarian Practice Network: Network Paper, 2003. 43.
104. Rogers, S. *Designed for Disassembly: Architecture Built with its Own End in Mind*. Architecture 2018 [cited 2020; Available from: <https://weburbanist.com/2018/11/21/designed-for-disassembly-architecture-built-with-its-own-end-in-mind/>].
105. Designing Buildings Wiki. *Design for deconstruction*. 2020 [cited 2020; Available from: https://www.designingbuildings.co.uk/wiki/Design_for_deconstruction].
106. Soh, S., S. Ong, and A. Nee, *Design for disassembly for remanufacturing: methodology and technology*. Procedia CIRP, 2014. 15: p. 407-412.
107. Muller, M. *This House Can Be Dismantled and Rebuilt in Hours So It Can Go Anywhere with You*. Architectural Digest Magazine, 2016.
108. Emilsson, T. and Å.O. Sang, *Impacts of climate change on urban areas and nature-based solutions for adaptation*, in *Nature-Based Solutions to Climate Change Adaptation in Urban Areas*. 2017, Springer, Cham. p. 15-27.
109. Depietri, Y. and T. McPhearson, *Integrating the grey, green, and blue in cities: Nature-based solutions for climate change adaptation and risk reduction*, in *Nature-based solutions to climate change Adaptation in urban areas*. 2017, Springer, Cham. p. 91-109.
110. Science for Environment Policy, *The Multifunctionality of Green Infrastructure*. 2012, DG Environment.
111. Pratiwi, R.D., I.S. Fatimah, and A. Munandar. *Spatial planning for green infrastructure in Yogyakarta City based on land surface temperature*. in *IOP Conference Series: Earth and Environmental Science*. 2018.
112. Andersson, E., S. Borgström, and T. McPhearson, *Double insurance in dealing with extremes: Ecological and social factors for making nature-based solutions last*, in *Nature-Based Solutions to Climate Change Adaptation in Urban Areas*. 2017, Springer, Cham. p. 51-64.
113. Williams, K., et al., *Suburban Neighbourhood Adaptation for a Changing Climate (SNACC) Final Report*. 2012.
114. Gupta, R. and M. Gregg, *Assessing resilience to summertime overheating in modern low energy flats in UK*, in *5th International Conference on Countermeasures to Urban Heat Islands (IC2UHI)*. 2019: Hyderabad, India.
115. Reardon, C. and D. Clarke. *Passive design: Passive cooling*. Passive Design 2013 [cited 2020 May 19]; Available from: <https://www.yourhome.gov.au/passive-design/passive-cooling>.
116. Agarwal, A., *Cyclone resistant building architecture*. 2007, UNDP India: New Delhi. p. 22.
117. Rupperta, K., et al. *Passive Solar Orientation*. 2015 [cited 2020 May 19]; Available from: <http://www.myfloridahomeenergy.com/help/library/choices/orientation/#sthash.tAioKtBH.nR5SYew1.dpbs>.

118. CLEAR, *Comfortable Low Energy ARchitecture*. 2020: <https://www.new-learn.info/>.
119. Nguyen, A.-T., et al., *An investigation on climate responsive design strategies of vernacular housing in Vietnam*. Building and Environment, 2011. 46(10): p. 2088-2106.
120. Anangpur Building Centre. *Juanapur Slum Resettlement*. 2013; Available from: <http://www.anangpur.org/jaunapur-slum-resettlement-2>.
121. Good Homes Alliance, *OVERHEATING IN NEW HOMES: Tool and guidance for identifying and mitigating early stage overheating risks in new homes*. 2019, Good Homes Alliance: London. p. 48.
122. CPWD, *Integrated Green Design for Urban & Rural Buildings in Hot-Dry Climate Zone*. 2013, Central Public Works Department: New Delhi. p. 7, 10, 12, 14, 21, 30.
123. McGee, C., C. Reardon, and D. Clarke. *Passive Design: orientation*. Australian Government. 2013; Available from: <https://www.yourhome.gov.au/passive-design/orientation>.
124. Priya, R.S., et al., *Solar passive techniques in the vernacular buildings of coastal regions in Nagapattinam, TamilNadu-India—a qualitative and quantitative analysis*. Energy and buildings, 2012. 49: p. 50-61.
125. Benhammou, M., et al., *Performance analysis of an earth-to-air heat exchanger assisted by a wind tower for passive cooling of buildings in arid and hot climate*. Energy conversion and management, 2015. 91: p. 1-11.
126. Dehghani-sanij, A.R., M. Soltani, and K. Raahemifar, *A new design of wind tower for passive ventilation in buildings to reduce energy consumption in windy regions*. Renewable and Sustainable Energy Reviews, 2015. 42: p. 182-195.
127. Kamal, M.A., *An overview of passive cooling techniques in buildings: Design concepts and architectural interventions*. Acta Technica Napocensis: Civil Engineering & Architecture, 2012. 55: p. 84-97.
128. Ouedraogo, B.I., G.J. Levermore, and J.B. Parkinson, *Future energy demand for public buildings in the context of climate change for Burkina Faso*. Building and Environment, 2012. 49: p. 270-282.
129. Bureau of Indian Standards, *National Building Code of India*. 2016.
130. Overbey, D., *Gauging the Impact of Exterior Shading using the Projection Factor*, in *The BE Blog*. 2019: BE Building Enclosure.
131. BEEP, *Energy Conservation building code for residential buildings*. 2017.
132. Indraganti, M., *Behavioural adaptation and the use of environmental controls in summer for thermal comfort in apartments in India*. Energy and buildings, 2010. 42(7): p. 1019-1025.
133. Al-Obaidi, K., M. Ismail, and A. Rahman, *Passive cooling techniques through reflective and radiative roofs in tropical houses in Southeast Asia: A literature review*. Frontiers of Architectural Research, 2014. 3.
134. Fouvet, C., *Heatwaves and cool roofs - Reimagining concrete solutions to a rising urban problem*, in *Shashwat Magazine*. 2017, GRIHA: New Delhi. p. 65-68.
135. Gupta, R. and M. Gregg, *Adapting UK suburban neighbourhoods and dwellings for a changing climate*. Advances in building energy research, 2011. 5(1): p. 81-108.
136. Nayak, J.K. and J.A. Prajapati, *Handbook on energy conscious buildings for climates in Indian context*, MNRE, Editor. 2006, IIT Bombay and Solar Energy Center.
137. Gupta, R. and M. Gregg, *Preventing the overheating of English suburban homes in a warming climate*. Building Research & Information, 2013. 41(3): p. 281-300.
138. BEE, *Energy Conservation Building Code (ECBC) 2017, in Compliance & Approach*. 2017, BEE: New Delhi, India. p. 66.
139. Agurto, L., et al., *Design and experimental study of a low-cost prefab Trombe wall to improve indoor temperatures in social housing in the Biobío region in Chile*. Solar Energy, 2020. 198: p. 704-721.
140. Zhang, H. and H. Shu, *A Comprehensive Evaluation on Energy, Economic and Environmental Performance of the Trombe Wall during the Heating Season*. Journal of Thermal Science, 2019. 28(6): p. 1141-1149.
141. Dabaieh, M. and A. Elbably, *Ventilated Trombe wall as a passive solar heating and cooling retrofitting approach; a low-tech design for off-grid settlements in semi-arid climates*. Solar Energy, 2015. 122: p. 820-833.
142. Chung, L.P., et al., *Effective Solar Chimney Cross Section Ventilation Performance in Malaysia Terraced House*. Procedia - Social and Behavioral Sciences, 2015. 179: p. 276-289.
143. Aboulnaga, M.M., *A roof solar chimney assisted by cooling cavity for natural ventilation in buildings in hot arid climates: An energy conservation approach in Al-Ain city*. Renewable Energy, 1998. 14(1): p. 357-363.
144. IGBC, *IGBC Rating System for Green Affordable Housing Pilot Version*. 2017, IGBC: Hyderabad. p. 9, 11, 21.
145. AAAMSA, *The Guide to Energy Efficient Thermal Insulation in Buildings*. 2010: South Africa.
146. Oliveira, R.D., et al., *Concrete Walls Thermal Performance Analysis by Brazilian Standards*. Energy Procedia, 2015. 78: p. 213-218.



147. Pimentel-Rodrigues, C. and A. Siva-Afonso. *Reuse of resources in the use phase of buildings. Solutions for water*. in *IOP Conference Series: Earth and Environmental Science*. 2019. IOP Publishing.
148. Baguma, D., et al., *Rainwater and Health in Developing Countries: A Case Study on Uganda*. 2012, United Nations University: Online. p. <https://unu.edu/publications/articles/rainwater-and-health-in-developing-countries-a-case-study-on-uganda.html>.
149. The Energy and Resources Institute, Institut Catala d'Energia, and Asia Urbs Programme, *Sustainable Building - Design Manual: sustainable building design practices*. 2004: Energy and Resources Institute.
150. Kheradmand, S., et al., *Evaluation of adaptation options to flood risk in a probabilistic framework*. *Journal of Hydrology: Regional Studies*, 2018. 19: p. 1-16.
151. Rajendran, K. *Flood-resistant housing attracts attention in Kerala*. *Flood and drought 2019* [cited 2020 May 19]; Available from: <https://india.mongabay.com/2019/07/flood-resistant-housing-attracts-attention-in-kerala/>.
152. Lai, J.Y. and H.H. Cheng, *Understanding Adaptation: Lessons from Local Adaptive Measures to Coastal Risks and Hazards—A Case Study of Kukup Water Village, Malaysia*. *Journal of Design and Built Environment*, 2019. 19(1): p. 13-23.
153. Lamond, J., et al., *Information for adaptation and response to flooding, multi-stakeholder perspectives in Nigeria*. *Climate*, 2019. 7(4): p. 46.
154. Singh, B., K. Hawley, and D. Singh, *Sheltering from a gathering storm: Flood resilience in India*. 2014.
155. Hochrainer-Stigler, S., J. Linnerooth-Bayer, and J. Mochizuki, *Flood proofing low-income houses in India: an application of climate-sensitive probabilistic benefit-cost analysis*. *Economics of Disasters and Climate Change*, 2019. 3(1): p. 23-38.
156. Wang, L., *6 amphibious houses that float to escape flooding*. 2017: INHABITAT. p. <https://inhabitat.com/6-amphibious-houses-that-float-to-escape-flooding/>.
157. Khanolkar, A.V., Jadhav, A.E. and Patekhede, A., 2019. A Review on: Amphibious House. *International Research Journal of Engineering and Technology (IRJET)*, 6(12), pp. 1093-1096. <https://www.irjet.net/archives/V6/i12/IRJET-V612178.pdf>
158. Mulligan, J., et al. *Community-responsive adaptation to flooding in Kibera, Kenya*. in *Proceedings of the Institution of Civil Engineers-Engineering Sustainability*. 2016. Thomas Telford Ltd.
159. New Jersey Institute of Technology. *Home shapes and roof that hold up best in hurricanes*. 2007 [cited 2020 09 June]; Available from: <https://www.sciencedaily.com/releases/2007/06/070619155735.htm>.
160. Casimiro, A., B. App, and M.O. Bata. *Climate change & resilience, housing & informality, climate change, climate change adaptation, Mozambique, urban resilience*. 2018 [cited 2020 May 19]; Available from: <https://www.urbanet.info/climate-resilient-housing-mozambiques-coastal-cities/>.
161. Taher, R., *Design of low-rise buildings for extreme wind events*. *Journal of architectural engineering*, 2007. 13(1): p. 54-62.
162. Amitrano, L., et al., *An assessment of the need to adapt buildings for the unavoidable consequences of climate change*, in *Report for Victorian Department of Sustainability and the Environment*. 2007.
163. Pérez, C.I., *Hurricane Resilient Wooden Houses: safer building and retrofitting guidelines*. 2017, Habitat for Humanity International: Kingston, Jamaica.
164. Fender, T., *Are Geodesic Dome Homes More Energy Efficient and Wind Resistant Because They Resemble a Hemisphere?*, in *Faculty of the department of mathematics*. 2010, Jacksonville University: Jacksonville, USA. p. 92.
165. Hannula, E.-L., *Going Green*, ed. C. Lalande. 2012, Nairobi: United Nations Human Settlements Programme.
166. Gupta, R. and M. Gregg, *Green building interventions for social housing*, ed. C. Lalande. 2015, Nairobi: United Nations Human Settlements Programme.
167. Fröhlich, S., *Sand mining decimates African beaches*, in *Deutsche Welle*. 2017.
168. Caleb, P.R., et al., *Mainstreaming Sustainable Social Housing in India Project MaS-SHIP: Technical Report WP 4*. 2019. p. 104.
169. UNEP, *Emerging Issues for Small Island Developing States: Results of the UNEP Foresight process*. 2014.
170. UN Habitat, *Urbanization and Climate Change in Small Island Developing States*. 2015, UN Habitat.
171. Sinha, S., *Architecture for rapid change and scarce resources*. 2012.
172. Norton, R., K. MacClune, and M. Szönyi, *When the unprecedented becomes preceded: Learning from Cyclones Idai and Kenneth*. 2020, ISET International and the Zurich Flood Resilience Alliance: Boulder, CO.
173. Amoako, C., *Emerging grassroots resilience and flood responses in informal settlements in Accra, Ghana*. *GeoJournal*, 2018. 83(5): p. 949-965.

UN 
**environment
programme**

50 
1972-2022

United Nations Avenue, Gigiri
P.O. Box 30552, 00100 Nairobi, Kenya
Tel. +254 20 762 1234
unep-publications@un.org
www.unep.org